

## Appendices

## Attachment 1

Questionnaire survey on "construction, utilization, and future needs of patent information retrieval system", toward holding patent information retrieval workshops and business contests

October 31<sup>st</sup>, 2021

Yoshitoshi Tanaka, ERIA new Project Team Leader  
Professor Emeritus, Tokyo Institute of Technology

Dear concerned in charge of this project  
in your national IPO; Intellectual Property Office

As we have already announced in our previous email and its attachment, ERIA has started a new research study on the utilization of patent information from this year. The purpose of this research is to show how local companies and universities in the ASEAN region can practically utilize patent information to promote innovation in each region in the future. To achieve this goal, we first decided to listen to the needs of IPO, companies, universities, patent agents, in each country regarding the utilization of patent information. Based on these local needs, we would like to hold a Workshop and Business Contest to understand practically of patent information retrieval and utilization, as a joint work between the IPO and the ERIA team. We sincerely ask for your active cooperation in making this project meaningful for you and your society.

Prior to the Workshop and Business Contest, we will conduct a questionnaire survey of IPO, local companies, universities, and patent agents in the ASEAN region regarding patent information retrieval and utilization. For IPO, we will mainly ask specific questions about the status of currently available patent information retrieval systems.

Please answer as much detail as possible by following the questions below.

Thank you for your cooperation in advance.

### *Questions for IPO in each country*

We will ask you questions according to the following items. Depending on the content of the question, please consult with the relevant departments and answer on behalf of the organization as much as possible. The answers to the questions are basically descriptive.

We would appreciate it if you could answer in as much detail and in an easy-to-understand manner as possible. We will take a look at the results of your answers, and if necessary, we will hold a zoom meeting between you and me for further detailed discussions.

First of all, please fill out your name, affiliation, and contact information.

Full name:

Affiliation:

Contact: e-mail address:

Tel:

Questions:

(1) Which of the following patent information databases is currently used by your country's IPO? Please make check  from the followings. Multiple answer is OK if you have.

- WIPO PatentScope
- ASEAN PatentScope
- WIPO IPAS
- Patent search DB system made by your IPO

(2) Do you have a patent information database built by your country's IPO?

Please make check  from the followings.

- Yes
- No

(3) If yes on (2), please specify the name and features of your own patent information database (system).

Name of your own patent information database (system):

(Please fill out here)

Features of your own patent information database (system):

(Please fill out here)

(4) What kind of media does your IPO provide patent information to public users? Please select from the following and check . Multiple answer is OK.

- Paper-based patent gazettes are provided upon request.
- The paper-based patent gazette file is available for viewing in the library in the IPO.
- The database can be accessed and searched from the terminal installed in the library in the IPO.
- From outside the IPO, the IPO database can be accessed and searched via the Internet.
- Others

*Note: From here to question (15), there are questions about the patent information database provided by your IPO for public users.*

(5) Is there a patent information database (system) currently provided by your IPO for public users? Please make check  from the followings.

- Yes
- No

(6) If yes on (5), please specify the name and features of your own patent information database (system) provided by your IPO for public users.

Name of your own patent information database (system):

(Please fill out here)

Features of your own patent information database (system):

(Please fill out here)



(7) If yes on (5), from which year to which year is the patent information stored in the patent information database provided for public users? (for example; from 1980 to 2020)

(For each type of patent information)

Overseas patent information

US issue year: from  to

Europe Publication year: from  to

Japan Publication year: from  to

Others Publication year: from  to

Patent Publication issued in your own country: from  to

(8)Terminology used to operate the database: English, native language (Check  one or all)

\* If there are multiple official languages as your native language, please write the name of the languages.

English

Native language

(Name of native languages; )

(9)Search term used for keyword search of the database: English, native language (Check  one or all)

\* If there are multiple official languages as your native language, please write the name of the languages.

English

Native language

(Name of native languages; )

(10)Display terms for bibliographic items in the database: English, native language (Check  one or all)

\* If there are multiple official languages as your native language, please write the name of the languages.

English

Native language

(Name of native languages; )

(11)Display term of abstract of the database: English, native language (Check  one or all)

\* If there are multiple official languages as your native language, please write the name of the languages.

English

Native language

(Name of native languages; )

(12)Display term of patent claims in the database: English, native language (Check  one or all)

\* If there are multiple official languages as your native language, please write the name of the languages.

English

Native language

(Name of native languages; )

(13)Display term of patent specification of the database: English, native language (Check  one or all)

\* If there are multiple official languages as your native language, please write the name of the languages.

English

Native language

(Name of native languages; )

(14)Publication status of the above database (5);

When the database was released to public users?:

Since the year  (for example; Since the year 2014)

Is it charged or free of charge?

Charged

Free of charge

(15)Please describe the functionality of the Internet search system of the above database(5) (for example; search function, display function, download function, easiness of use, etc.) as specifically as possible.

(Please fill out here)

Note; Now, returned back to the general questions from here.

(16) Please describe as specifically as possible about the advantages and disadvantages of the usage of patent information database.

(Please fill out here)

(17) Please describe as specifically as possible what IPO knows about the advantages and disadvantages of the usage of the patent information database by the local company.

(Please fill out here)

(18) Please describe as specifically as possible what the IPO knows about the advantages and disadvantages of the usage of the patent information database by the local university.  
(Please fill out here)

(19) Please describe as specifically as possible about the future policy of IPO regarding the database construction (including data update, continuation, development, problems to be solved, revise, etc.).  
(Please fill out here)

(20) Please describe as specific as possible regarding your financial plans to build and update the database (open to users for free, government funding, or charge external users, etc.).  
(Please fill out here)

(21)Please describe as specifically as possible about the status of human resource development such as education and training for patent information search engineers (current status, future policy, etc.).  
(Please fill out here)

(22)Please describe as specifically as possible on the problems that the IPO has regarding patent information retrieval.  
(Please fill out here)

(23)Describe as specifically as possible what IPO knows about the user's problems with patent information retrieval.  
(Please fill out here)

From here, please answer each of the following question on a 5-point scale. Please select from the following and check .

(24) The technology described in the patent information can be a hint for further research and development.

- 5: I completely agree
- 4: I agree
- 3: I can't say either
- 2: I disagree
- 1: I disagree at all

(25) Analyzing the patent information helps prevent duplication of R & D activities.

- 5: I completely agree
- 4: I agree
- 3: I can't say either
- 2: I disagree
- 1: I disagree at all

(26) It is meaningful to utilize the analysis results of patent information for formulating business strategies of companies.

- 5: I completely agree
- 4: I agree
- 3: I can't say either
- 2: I disagree
- 1: I disagree at all

(27) Analysis of patent information is useful for forecasting product demand and market.

- 5: I completely agree
- 4: I agree
- 3: I can't say either
- 2: I disagree
- 1: I disagree at all

(28) Analyzing patent information is important for a company to win the competition with its competitors.

- 5: I completely agree

- 4: I agree
- 3: I can't say either
- 2: I disagree
- 1: I disagree at all

(29) When exercising a patent right, it is necessary to search for patent information.

- 5: I completely agree
- 4: I agree
- 3: I can't say either
- 2: I disagree
- 1: I disagree at all

(30) In M & A and business-to-business contracts, patent information is useful for negotiations with partner companies.

- 5: I completely agree
- 4: I agree
- 3: I can't say either
- 2: I disagree
- 1: I disagree at all

(31) When selling a product, a company needs to check for infringement of another company's patent in order to obtain Freedom to Operate.

- 5: I completely agree
- 4: I agree
- 3: I can't say either
- 2: I disagree
- 1: I disagree at all

(32) In order to invalidate the patent rights held by other companies, it is necessary to search for patent information.

- 5: I completely agree
- 4: I agree
- 3: I can't say either
- 2: I disagree
- 1: I disagree at all

(33) Patent information is useful when selecting a license partner.

- 5: I completely agree
- 4: I agree
- 3: I can't say either
- 2: I disagree
- 1: I disagree at all

(34) Patent information retrieval should be free of charge using the Internet.

- 5: I completely agree
- 4: I agree
- 3: I can't say either
- 2: I disagree
- 1: I disagree at all

(35) Our company should develop human resources for patent information retrieval.

- 5: I completely agree
- 4: I agree
- 3: I can't say either
- 2: I disagree
- 1: I disagree at all

(36) Utilization of patent information retrieval system is important for innovation creation in our country.

- 5: I completely agree
- 4: I agree
- 3: I can't say either
- 2: I disagree
- 1: I disagree at all

(37) Utilization of patent information retrieval system will lead to increase of patent applications by companies in our country.

- 5: I completely agree
- 4: I agree
- 3: I can't say either
- 2: I disagree
- 1: I disagree at all



(38) Utilization of patent information retrieval system is important for company's growth.

- 5: I completely agree
- 4: I agree
- 3: I can't say either
- 2: I disagree
- 1: I disagree at all

(39) Utilization of patent information retrieval system contributes to the development of industry.

- 5: I completely agree
- 4: I agree
- 3: I can't say either
- 2: I disagree
- 1: I disagree at all

Thank you for your cooperation.

Based on the contents of your answers, we will plan and hold workshops and business contests, while consulting with you more specifically.

We sincerely hope that we will be able to work together through close communication in the future.

Warmest regards,

Yoshitoshi Tanaka

ERIA new Project Team Leader

Questionnaire survey on "construction, utilization, and future needs of patent information DB system", on the occasion of patent information workshops

Yoshitoshi Tanaka, ERIA Project WG Leader  
Professor Emeritus, Tokyo Institute of Technology

Dear concerned in your university,

We have prepared questions for universities. The questions 4-58 will be answered with five level 5, 4, 3, 2, 1, telling the degree of consent for each question. Please answer what you feel, not the answer that represents the organization to which you belong. We will analyze by statistical processing, so we need answers from many people with individual thinkings.

First of all, please fill out your name, affiliation, and contact information.

Your name	
University name	
e-mail address	
Phone number	

1	"I know the following patent information DB system." Please make check <input checked="" type="checkbox"/> from the followings. Multiple answer is OK if you know.
---	--

- WIPO PatentScope
- ASEAN PatentScope
- WIPO IPAS
- Patent search DB system made by your national IP Office
- Others

2	What is the patent information DB system normally used at your university, including commercial databases? Please answer the name of the database.
	Name of the database:
	Please introduce any features of this system. (Descriptive formula): (fill out here)

3	Do you have any requests for the patent information DB system you are currently using? Please answer your specific requests. Problems are fine. (Descriptive formula)
	Please introduce any features of this system. (Descriptive formula): (fill out here)

\* From here, please answer each of the following questions on a 5-point scale. You can answer in the answer column with circling the number 5 4 3 2 1.

**5: Fully agree, 4: Agree, 3: Can not say either, 2: Not agree, 1: Not agree at all**

	(Example)	Circle; 5, <u>4</u> , 3, 2, 1
4	I have used a patent information retrieval system.	Circle; 5, 4, 3, 2, 1
5	It is easy for me to access the database and search for patent information.	Circle; 5, 4, 3, 2, 1
6	The development of a patent information retrieval system is important for strengthening the competitiveness of universities.	Circle; 5, 4, 3, 2, 1
7	The patent information retrieval system needs to be available on the Internet.	Circle; 5, 4, 3, 2, 1
8	Domestic patent information retrieval systems need to be available in English in addition to the local language.	Circle; 5, 4, 3, 2, 1
9	The patent information retrieval system needs to be available free of charge.	Circle; 5, 4, 3, 2, 1
10	The National Intellectual Property Office must take leadership in building a patent information retrieval system.	Circle; 5, 4, 3, 2, 1
11	Utilization of commercial databases is not available due to the high cost.	Circle; 5, 4, 3, 2, 1
12	Patent information is important in promoting research and development at universities.	Circle; 5, 4, 3, 2, 1
13	Patent information is not so important in promoting research and development at universities.	Circle; 5, 4, 3, 2, 1
14	Patent information is useful for science and technology research conducted at universities.	Circle; 5, 4, 3, 2, 1
15	Patent information is useful for setting research themes for university science and technology research.	Circle; 5, 4, 3, 2, 1
16	Patent information helps us find themes for collaborative research with companies.	Circle; 5, 4, 3, 2, 1
17	Patent information is useful for basic research at universities.	Circle; 5, 4, 3, 2, 1
18	Patent information is important for commercial research in universities.	Circle; 5, 4, 3, 2, 1
19	Patent information is useful when universities collaborate with companies.	Circle; 5, 4, 3, 2, 1
20	Universities have applied for patents on the results of joint research with companies.	Circle; 5, 4, 3, 2, 1
21	Patent information is useful for grasping the technological development status of companies in the research and development area of universities.	Circle; 5, 4, 3, 2, 1
22	Companies' patent information is useful for advancing research and development at universities.	Circle; 5, 4, 3, 2, 1
23	The technology described in the patent information of a company can be a hint for research and development at a university.	Circle; 5, 4, 3, 2, 1
24	Analyzing companies' patent information helps prevent duplication of research and development at universities.	Circle; 5, 4, 3, 2, 1

25	Regarding the results of research and development conducted by our university, we are constantly considering whether or not to apply for a patent.	Circle; 5, 4, 3, 2, 1
26	Our university has applied for a patent on our research and development results.	Circle; 5, 4, 3, 2, 1
27	When filing a patent application, patent information is searched to evaluate novelty and inventive step.	Circle; 5, 4, 3, 2, 1
28	We have analyzed patent information and used it to formulate R & D strategies at universities.	Circle; 5, 4, 3, 2, 1
29	Analysis of patent information is useful for forecasting product demand and market.	Circle; 5, 4, 3, 2, 1
30	Analyzing patent information is important to win the competition with companies in the research and development area of universities.	Circle; 5, 4, 3, 2, 1
31	Our university has the experience of obtaining patent rights for university technology.	Circle; 5, 4, 3, 2, 1
32	Our university has exercised legal rights against companies based on our patent rights.	Circle; 5, 4, 3, 2, 1
33	We have searched for patent information when exercising patent rights.	Circle; 5, 4, 3, 2, 1
34	We have used patent information in negotiations with businesses contracts between university and company.	Circle; 5, 4, 3, 2, 1
35	Our university has been warned of patent infringement based on the patent rights held by a company.	Circle; 5, 4, 3, 2, 1
36	It is important to search for patent information in order to invalidate the patent rights held by others.	Circle; 5, 4, 3, 2, 1
37	Our university has been licensed based on the patent rights owned by companies.	Circle; 5, 4, 3, 2, 1
38	Our university has licensed the patent rights owned by our university to a company.	Circle; 5, 4, 3, 2, 1
39	Patent information is useful when selecting a license partner company.	Circle; 5, 4, 3, 2, 1
40	Our university routinely monitors the patent information of companies in the research and development area of the university.	Circle; 5, 4, 3, 2, 1
41	Our university laboratories make full use of patent information.	Circle; 5, 4, 3, 2, 1
42	Our university utilizes an online system when searching for patent information. retrieval.	Circle; 5, 4, 3, 2, 1
43	At our university, patent information is searched using paper-based publications.	Circle; 5, 4, 3, 2, 1
44	Patent information retrieval should be free of charge using the Internet.	Circle; 5, 4, 3, 2, 1
45	The patent information search is performed in the library of the National Intellectual Property Office.	Circle; 5, 4, 3, 2, 1
46	Our university has staff specializing in patent information retrieval.	Circle; 5, 4, 3, 2, 1
47	At our university, we are developing human resources for patent information retrieval.	Circle; 5, 4, 3, 2, 1
48	Our university uses an external institution to search for patent information.	Circle; 5, 4, 3, 2, 1
49	Research on the valuation of patent rights requires analysis of patent information.	Circle; 5, 4, 3, 2, 1

50	In order to promote industry-academia collaboration, it is necessary to analyze patent information.	Circle; 5, 4, 3, 2, 1
51	In the IOT field, patent information retrieval and utilization are important.	Circle; 5, 4, 3, 2, 1
52	In the AI field, patent information retrieval and utilization are important.	Circle; 5, 4, 3, 2, 1
53	We hope that the National Intellectual Property Office will actively carry out education, training, and dissemination activities for patent information retrieval.	Circle; 5, 4, 3, 2, 1
54	Utilization of patent information retrieval system is important for innovation creation in our country.	Circle; 5, 4, 3, 2, 1
55	Utilization of patent information retrieval system will lead to increase of patent applications by universities/companies in our country.	Circle; 5, 4, 3, 2, 1
56	Utilization of the patent information retrieval system is important for improving the ranking of universities.	Circle; 5, 4, 3, 2, 1
57	Utilization of patent information retrieval system is important for companies' growth.	Circle; 5, 4, 3, 2, 1
58	Utilization of patent information retrieval system contributes to the development of industry.	Circle; 5, 4, 3, 2, 1

**Please make answering all questions during the workshop, and submit it to me by the end of workshop.**

Thank you for your cooperation.

See you again, working together through close communication in the future.

Warmest regards,

Yoshitoshi Tanaka

Professor Emeritus, Tokyo Institute of Technology

Questionnaire survey on "construction, utilization, and future needs of patent information DB system", on the occasion of patent information workshops

Yoshitoshi Tanaka, ERIA Project WG Leader  
Professor Emeritus, Tokyo Institute of Technology

Dear concerned in your company,

We have prepared questions for companies. The questions 4-46 will be answered with five level 5, 4, 3, 2, 1, telling the degree of consent for each question. Please answer what you feel, not the answer that represents the organization to which you belong. We will analyze by statistical processing, so we need answers from many people with individual thinkings.

First of all, please fill out your name, affiliation, and contact information.

Your name	
Company name	
e-mail address	
Phone number	

1	"I know the patent information retrieval system." Please make check <input checked="" type="checkbox"/> from the followings. Multiple answer is OK if you have.
---	--

- WIPO PatentScope  
 ASEAN PatentScope  
 WIPO IPAS  
 Patent search DB system made by your IP Office  
 Others

2	What is the patent information retrieval database system used at your company, including commercial databases? Please answer the name of the database.
---	--

Name of the database:

Please introduce any features of this system. (Descriptive formula):  
(fill out here)

3	Do you have any requests for the patent information DB system you are currently using? Please answer your specific requests. Problems are fine. (Descriptive formula)
---	---

Please introduce any features of this system. (Descriptive formula):  
(fill out here)

\* From here, please answer each of the following questions on a 5-point scale. You can answer in the answer column in a pull-down format.

**5: Fully agree, 4: Agree, 3: Can not say either, 2: Not agree, 1: Not agree at all**

	(Example)	Circle; 5, <u>4</u> , 3, 2, 1
4	I have used a patent information retrieval system.	Circle; 5, 4, 3, 2, 1
5	It is easy for me to access the database and search for patent information.	Circle; 5, 4, 3, 2, 1
6	The development of a patent information retrieval system is important for strengthening the competitiveness of companies.	Circle; 5, 4, 3, 2, 1
7	The patent information retrieval system needs to be available on the Internet.	Circle; 5, 4, 3, 2, 1
8	Domestic patent information retrieval systems need to be available in English in addition to the local language.	Circle; 5, 4, 3, 2, 1
9	The patent information retrieval system needs to be available free of charge.	Circle; 5, 4, 3, 2, 1
10	The Intellectual Property Office must take leadership in building a patent information retrieval system.	Circle; 5, 4, 3, 2, 1
11	Utilization of commercial databases is not available due to the high cost.	Circle; 5, 4, 3, 2, 1
12	Patent information is important in promoting our business.	Circle; 5, 4, 3, 2, 1
13	Patent information is not so important in promoting our business.	Circle; 5, 4, 3, 2, 1
14	Patent information is useful for grasping the technological development status of other companies in our business area.	Circle; 5, 4, 3, 2, 1
15	The patent information of other companies is useful for advancing our research and development.	Circle; 5, 4, 3, 2, 1
16	The technology described in the patent information of other companies can be a hint for our research and development.	Circle; 5, 4, 3, 2, 1
17	Analyzing the patent information of other companies helps prevent duplication of R & D activities.	Circle; 5, 4, 3, 2, 1
18	We are constantly considering whether or not we should apply for a patent for the results of our research and development.	Circle; 5, 4, 3, 2, 1
19	Our company has applied for a patent for our research and development results.	Circle; 5, 4, 3, 2, 1
20	When filing a patent application, patent information is searched to evaluate novelty and inventive step.	Circle; 5, 4, 3, 2, 1
21	Our company has analyzed patent information and used it to formulate our business strategy.	Circle; 5, 4, 3, 2, 1
22	Analysis of patent information is useful for forecasting product demand and market.	Circle; 5, 4, 3, 2, 1
23	Analyzing patent information is important to win the competition with competitors in our business domain.	Circle; 5, 4, 3, 2, 1
24	Our company has the experience of obtaining patent rights for our technology.	Circle; 5, 4, 3, 2, 1
25	Our company has exercised its rights against other companies based on the patent rights acquired by our company.	Circle; 5, 4, 3, 2, 1
26	Our company has searched for patent information when exercising patent rights.	Circle; 5, 4, 3, 2, 1

27	Our company has used patent information when negotiating with partner companies in M & A and business-to-business contracts.	Circle; 5, 4, 3, 2, 1
28	Our company has been warned of infringement of patent rights on our products based on the patent rights held by other companies.	Circle; 5, 4, 3, 2, 1
29	When selling our products, we try to check for infringement of patents of other companies to get FTO (Freedom to Operate Search).	Circle; 5, 4, 3, 2, 1
30	In order to invalidate the patent rights held by other companies, it is necessary to search for patent information.	Circle; 5, 4, 3, 2, 1
31	Our company has been licensed for patent rights owned by other companies.	Circle; 5, 4, 3, 2, 1
32	Patent information is useful when selecting a license partner company.	Circle; 5, 4, 3, 2, 1
33	Our company routinely monitors the patent information of other companies in our business area.	Circle; 5, 4, 3, 2, 1
34	Our company has fully utilized patent information.	Circle; 5, 4, 3, 2, 1
35	Our company uses an online system to search for patent information.	Circle; 5, 4, 3, 2, 1
36	Our company searches for patent information using paper-based publications.	Circle; 5, 4, 3, 2, 1
37	Patent information retrieval should be free of charge using the Internet.	Circle; 5, 4, 3, 2, 1
38	The patent information search is performed in the library of the Intellectual Property Office.	Circle; 5, 4, 3, 2, 1
39	We have employees who specialize in patent information retrieval.	Circle; 5, 4, 3, 2, 1
40	Our company is developing human resources for patent information retrieval.	Circle; 5, 4, 3, 2, 1
41	Our company uses an external organization to search for patent information.	Circle; 5, 4, 3, 2, 1
42	We hope that the Intellectual Property Office will actively carry out education, training, and dissemination activities for patent information retrieval.	Circle; 5, 4, 3, 2, 1
43	Utilization of patent information retrieval system is important for innovation creation in our country.	Circle; 5, 4, 3, 2, 1
44	Utilization of patent information retrieval system will lead to increase of patent applications by companies in our country.	Circle; 5, 4, 3, 2, 1
45	Utilization of patent information retrieval system is important for corporate growth.	Circle; 5, 4, 3, 2, 1
46	Utilization of patent information retrieval system contributes to the development of industry.	Circle; 5, 4, 3, 2, 1

**Please make answering all questions during the workshop, and submit it to me by the end of workshop.**

Thank you for your cooperation.

See you again, working together through close communication in the future.

Warmest regards,

Yoshitoshi Tanaka

Professor Emeritus, Tokyo Institute of Technology



Attachment 4

Questionnaire survey on "construction, utilization, and future needs of patent information DB system", on the occasion of patent information workshops

Yoshitoshi Tanaka, ERIA Project WG Leader  
 Professor Emeritus, Tokyo Institute of Technology

Dear concerned in your law firm,

We have prepared questions for IP law firms. The questions 4-27 will be answered with five level 5, 4, 3, 2, 1, telling the degree of consent for each question. Please answer what you feel, not the answer that represents the organization to which you belong. We will analyze by statistical processing, so we need answers from many people with individual thinkings.

First of all, please fill out your name, affiliation, and contact information.

Your name	
Affiliation name	
e-mail address	
Phone number	

1	"I know the patent information retrieval system." Please make check <input checked="" type="checkbox"/> from the followings. Multiple answer is OK if you have.
---	--

- WIPO PatentScope
- ASEAN PatentScope
- WIPO IPAS
- Patent search DB system made by your IP Office
- Others

2	What is the patent information retrieval database system used at your law firm, including commercial databases? Please answer the name of the database.
---	---

Name of the database:	
-----------------------	--

Please introduce any features of this system. (Descriptive formula): (fill out here)	
---	--

3	Do you have any requests for the patent information DB system you are currently using? Please answer your specific requests. Problems are fine. (Descriptive formula)
---	---

Please introduce any features of this system. (Descriptive formula): (fill out here)	
---	--

\* From here, please answer each of the following questions on a 5-point scale. You can answer in the answer column in a pull-down format.

**5: Fully agree, 4: Agree, 3: Can not say either, 2: Not agree, 1: Not agree at all**

	(Example)	Circle; 5, <input checked="" type="radio"/> 4, 3, 2, 1
4	It is useful to search for patent information in advance when acting on behalf of a patent application.	Circle; 5, 4, 3, 2, 1
5	If requested by the client of the patent application, we will search for the patent application.	Circle; 5, 4, 3, 2, 1
6	It is useful for the IP law firm/agent to utilize the prior art information disclosed in the issued patent information when drafting the specification of the patent application.	Circle; 5, 4, 3, 2, 1
7	We constantly monitor the patent information of the client's business area.	Circle; 5, 4, 3, 2, 1
8	We support the client by searching and analyzing patent information in the client's business area.	Circle; 5, 4, 3, 2, 1
9	When applying for invalidation of another company's patent at the request of the client, we will search for patent information.	Circle; 5, 4, 3, 2, 1
10	When applying for invalidation of another company's patent, we utilize an external organization to search for patent information.	Circle; 5, 4, 3, 2, 1
11	When a client receives a warning of patent infringement from another company, it is important to search for patent information as a countermeasure.	Circle; 5, 4, 3, 2, 1
12	If the client is sued by another company for patent infringement, it is important to search for patent information.	Circle; 5, 4, 3, 2, 1
13	Patent information retrieval helps the client's business.	Circle; 5, 4, 3, 2, 1
14	Patent information retrieval engineers should be trained within IP-related law firm/agent.	Circle; 5, 4, 3, 2, 1
15	Patent information retrieval is the scope of business of IP-related law firm/agent.	Circle; 5, 4, 3, 2, 1
16	Patent information retrieval is not the scope of the business of IP-related law firm/agent.	Circle; 5, 4, 3, 2, 1
17	Patent information retrieval should be free of charge using the Internet.	Circle; 5, 4, 3, 2, 1
18	Education, training and dissemination activities for patent information retrieval should be carried out more actively.	Circle; 5, 4, 3, 2, 1
19	We have analyzed patent information and used it to formulate our business strategy.	Circle; 5, 4, 3, 2, 1
20	Analysis of patent information is useful for forecasting product demand and market.	Circle; 5, 4, 3, 2, 1
21	Analyzing patent information is important to win the competition with competitors in the client company's business domain.	Circle; 5, 4, 3, 2, 1
22	It is important for the IP law firm/agent to have the ability to search patent information and to analyze and utilize the patent information in order to improve the satisfaction of the client.	Circle; 5, 4, 3, 2, 1
23	We hope that the Intellectual Property Office will actively carry out education, training, and dissemination activities for patent information retrieval.	Circle; 5, 4, 3, 2, 1

24	Utilization of patent information retrieval system is important for innovation creation in our country.	Circle; 5, 4, 3, 2, 1
25	Utilization of patent information retrieval system will lead to increase of patent applications by universities/companies in our country.	Circle; 5, 4, 3, 2, 1
26	Utilization of patent information retrieval system is important for companies' growth.	Circle; 5, 4, 3, 2, 1
27	Utilization of patent information retrieval system contributes to the development of industry.	Circle; 5, 4, 3, 2, 1

**Please make answering all questions during the workshop, and submit it to me by the end of workshop.**

Thank you for your cooperation.

See you again, working together through close communication in the future.

Warmest regards,

Yoshitoshi Tanaka

Professor Emeritus, Tokyo Institute of Technology

## Attachment 5

### **Holding Workshops and Invention Business Contests on Patent Information Retrieval Education and Dissemination (Proposal)**

ERIA WG Leader

Yoshitoshi Tanaka

#### **Purpose of holding workshops and invention business contests**

Utilizing the patent system that has already been established as a global standard, more than 4 million patent applications are filed annually around the world. In response to this, patent information exceeding this number of applications is issued every year. The number of patent information issued far exceeds the number of academic research publications, and expectations for the effective use of patent information are increasing. In other words, not only the prior arts search at the time of filing, but also future technology prediction, national policy making, competitiveness measurement between companies, corporate management strategy, R & D strategy, corporate value evaluation, explanation to shareholders and investors, setting research theme at universities and research institutes, etc., the utilization of a wide range of patent information has been getting required. In addition, patent information is an absolutely effective material for promoting further innovation in each country. In order to utilize patent information in these ways, it is necessary to provide opportunities for education, training, and dissemination and enlightenment regarding the methods of patent search and patent analysis, etc.

Therefore, this time, we will hold patent information retrieval workshops and invention business contests with the cooperation of the national IP Office of each ASEAN country, and provide opportunities for conducting education, training, and dissemination and enlightenment activities for the utilization of patent information.

#### **Organizer / collaborator:**

IPO in each country/ ERIA; Economic Research Institute for ASEAN and East Asia

#### **Date and place:**                    \*Waiting for your decision soon!

\*Up to the decision made by National IPO

\*For the timing, during the period April – June, 2022

#### **Participants:**

IPO Executives and staff, Universities' Researchers and staff, Companies' Executives and IP staff, Law firms' lawyer and IP staff, Universities' students, etc.

\*Please invite many people from different stakeholders when the schedule has been decided.

#### **How to hold a workshop on patent information retrieval and an invention business contest?**

Workshops and invention business contests related to patent information retrieval education and training are **two-day programs** that are held as practical education, training, and dissemination and enlightenment activities for patent information retrieval.

Workshops and invention business contests will be held in each ASEAN country, hosted by the local IP Office in

each country. The ERIA working group of this project will substantially support the activities of the local IP Office, including financial assistance for holding workshops and contests. Since it is assumed that it will be difficult for WG members to make a business trip to the site during the corona pandemic, the WG will cooperate on an online basis. The agenda of the workshop was "Importance of patent information for business growth", "Current status of patent information retrieval system", "How to use PatentScope and local systems of ASEAN countries", "Practical demonstration and practice of search system", etc. These lectures will be given by local IP Offices and ERIA WG experts, etc., on the attached agendas, and participants will be educated on patent information retrieval. At the contest, a patent information search task is given and the search results are submitted within a arranged time.

Summarizing the main points on these events are as follows.

- ① A patent information retrieval workshop and invention business contest will be held by the local IP Office in the countries of ASEAN, with assistance by ERIA.
- ② This year, because of the corona pandemic, the event will be held without dispatching experts from ERIA WG. It is up to the local IPO to decide whether the event will be held locally, in a collective format, online format, or in a hybrid format.
- ③ Holding “Workshop” inviting IP experts on Patent Information Retrieval and its Utilization
- ④ Holding “Invention business contest” to give assignments and compete for patent information retrieval.
- ⑤ Extract factors that popularize patent information retrieval through holding workshops and contests
- ⑥ Collect opinions and expectations for the future activities regarding patent information retrieval and its utilization, before and after workshops and contests.

### **Day 1: Lecture and discussions at the workshop**

Educate participants on patent information retrieval through lectures and questions by local IP agencies, local universities, etc., and ERIA WG IP experts.

#### **Workshop Program (proposal)**

9:00-9:15	Welcome speech by the executives of IPO
9:15-9:30	Welcome speech by ERIA Director, Mr. Taizo Hara
9:30-10:00	Purpose of workshop, including practical information by IPO manager
10:00-10:15	Coffee break
10:15-11:00	Lecture 1:” Basic Understanding of a Patent and Patent Search” by Mr. Koyama, lawyer
11:00-11:45	Lecture 2:” How to use Local DB, WIPO DB, USP DB for patent search” by local IP expert
11:45-12:15	Q&A Discussions
12:15-13:00	Lunch break
13:00-13:45	Lecture 3:” Utilizing intelligence of patent information for revenue business models” by Prof. Moriya, KIT
13:45-14:30	Lecture 4:” When and for what purpose should we make patent information search” by Mr. Katsunuma, IP Dept Manager, Ajinomoto

14:30-15:00	Q&A Discussions (including break)
15:00-15:45	Lecture and demonstration on patent information retrieval by local IP expert
15:45-16:00	Q&A Discussions
16:00	Closing for Day1

### Proposals for lectures from ERIA WG side:

- “Basic Understanding of a Patent and Patent Search”; Takashi Koyama, Attorney-at-law (Japan and State of New York), Patent attorney
- “Utilizing intelligence of patent information for revenue business models”: Fumihiko Moriya, Visiting Professor, Kanazawa Institute of Technology
- “When and for what purpose should we make patent information search”: Yori-hisa Katsunuma, General Manager, Intellectual Property Dept., Ajinomoto Co., Inc.
- “Analysis and Definition of Baseline for Intellectual Property Education”: Yoshitoshi Tanaka, Professor Emeritus, Tokyo Institute of Technology
- “Selected topics (a) whether an invention should be protected by patent or trade secret, (b) basic patent and applied patent, and (c) Open and Close Strategy”: Takeshi Koyama, Attorney-at-law (Japan and State of New York), Patent attorney

### **Day 2: Invention Business Contest:**

In the invention business contest, a patent information search task is given and the search results are submitted within a set time.

#### Contest Program (proposal)

9:00-9:30	Information and instruction of invention business contest by IPO & ERIA
9:30-10:00	Demonstration of local DB, WIPO DB, USP DB, etc. by local IP expert
10:00-10:30	Explanation of the invention for patent searching by ERIA WG
10:30-12:00	Patent searching contest exercise
12:13:00	Lunch break
13:00-14:00	Reporting work (paper or PC base)
14:00-15:00	Presentation by participants facilitated by IPO and ERIA
15:00-15:30	Coffee break
15:30-16:00	Awarding & Closing Ceremony

#### Basic flow of Invention Business Contest:

- ① Create a virtual case of the invention and explain the technical content to the participants. As a point at this time, necessary and sufficient technical information must be explained so that the participant can grasp the content of the invention and set the search keyword of the patent information.
- ② Participants must understand the content of the invention, set appropriate keywords, and perform search work.
- ③ Participants use search keyword settings, keyword multiplication, and international patent classification to

narrow down the search and extract prior art information and patents of others. The point at this time is to repeat the search work until an appropriate result is reached while confirming that the search result is complete.

- ④ The search results are reported in the form of the search formula used for the search, the number of patent information obtained by the search, and the case explanation (several cases) of the patent information closest to the present invention. Participants must also consider the following three issues regarding the obtained search results.
- ⑤ Based on the extracted prior art, (1) consider whether the invention of this case may be patented (whether or not it meets the patent requirements). We will not discuss the novelty and inventive step in detail this time, but focus on the practical understanding of the search method of the prior art.
- ⑥ In addition, if a patent granted by others is found, it must be considered whether or not there is a possibility of (2) patent infringement by implementing the invention of this case. Whether or not there is infringement of rights requires a comparison between the composition of the invention to be implemented and the scope of rights of the patents of others. However, a detailed discussion of infringement will not be discussed this time, but will focus on a practical understanding of prior art search methods.
- ⑦ Furthermore, with respect to the existence of prior art and patents of others, participants will consider (3) whether the invention can be improved to obtain rights or avoid patents of others (improved examples of the invention).

Proposals from ERIA WG of the inventions to be searched: (\* IPO propose and decide it.)

Titles of Invention are as follows. The abstracts of these inventions are available if you need at present.

- “Glass coating having super repellent performance to the windshield of an automobile”
- “Removable razor cartridge having magnetic elements”
- “Method for producing microwave-resistant sheet for heat-insulating foamed paper container”
- “Writing Instrument”

# What & How we should understand Patent Information Searching?

- Guideline for patent information searching Contest -

Yoshitoshi Tanaka

ERIA WG Leader

Professor Emeritus, Tokyo Institute of Technology



# 2 Basic Concepts of Patent Information Searching

We **know** the specific number of publication

## I. Specific Publication No. Searching

- (1) In case National IPO (or foreign IPO) sends office actions to the applicant, which patent examiner tells the prior arts with specific publication No., in connection with the reason of refusal.

If the patent publications are local publications, we have to check IPPlatform or National IPO DB, and request to have all document to National IPO if necessary.

If the patents are foreign, we have to check the all related data and document by using WIPO PatentScope, or other global DB.

- (2) In case of receiving warning letter from competitors for patent infringement, together with the specific patent No. We have to check the registration of the patents.

We **don't know** the specific number of publication

## II. Specific Technology Searching

## II. Specific Technology Searching

(1) **In case of filing patent application** to National IPO (or to foreign IPO), we have to evaluate the patentability on our invention in advance.

To make technology searching, first we have to define our invention clearly by using technical elements, as a technical combination [A, B, C, D, E].

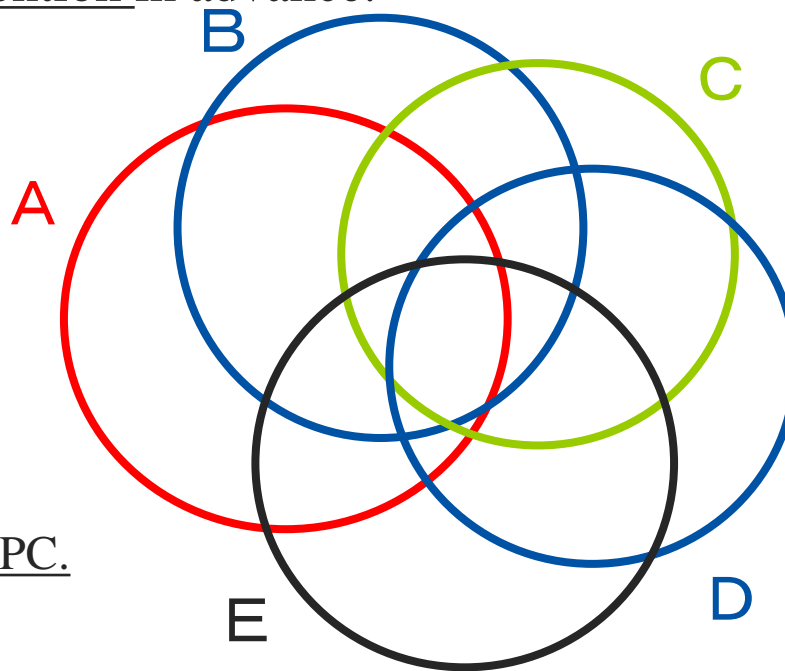
**“What is the subject of invention for searching?”**

We make specific technology searching using technical key word; simple/multiple key words, IPC.

If we find [A, B, C, D, E], lack of novelty.

If we find some combination like [A, B, C]+[C, D, E], lack of inventive step.

→Variation for searching; [A, B, C, D]+[D, E], [A, B]+[B, C, D, E], etc.



(2) In case of R&D activities, we need to make specific technology searching in order to make our R&D activities more efficient. We can extract technical features from this search results, by technical fields, by companies, historical trend, future perspectives, analysis between technology and marketing, etc.

Expectation & Benefits: We can expect to have information on the followings, by making patent publication searching.

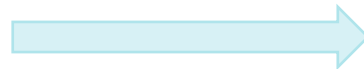
✓ Technology background



Technology scouting/utilization,  
technological improvement

✓ Technology history

✓ Technology roadmap



R&D strategy

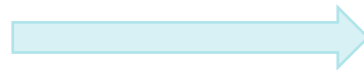
✓ Discrimination against competitors' technology

✓ Future development by technical improvement

Define business domain, business  
competency

✓ Innovation

✓ Technology valuation



New business/industry, start-up

Realize open-innovation

✓ Licensing strategy

Business strategy, Business growth

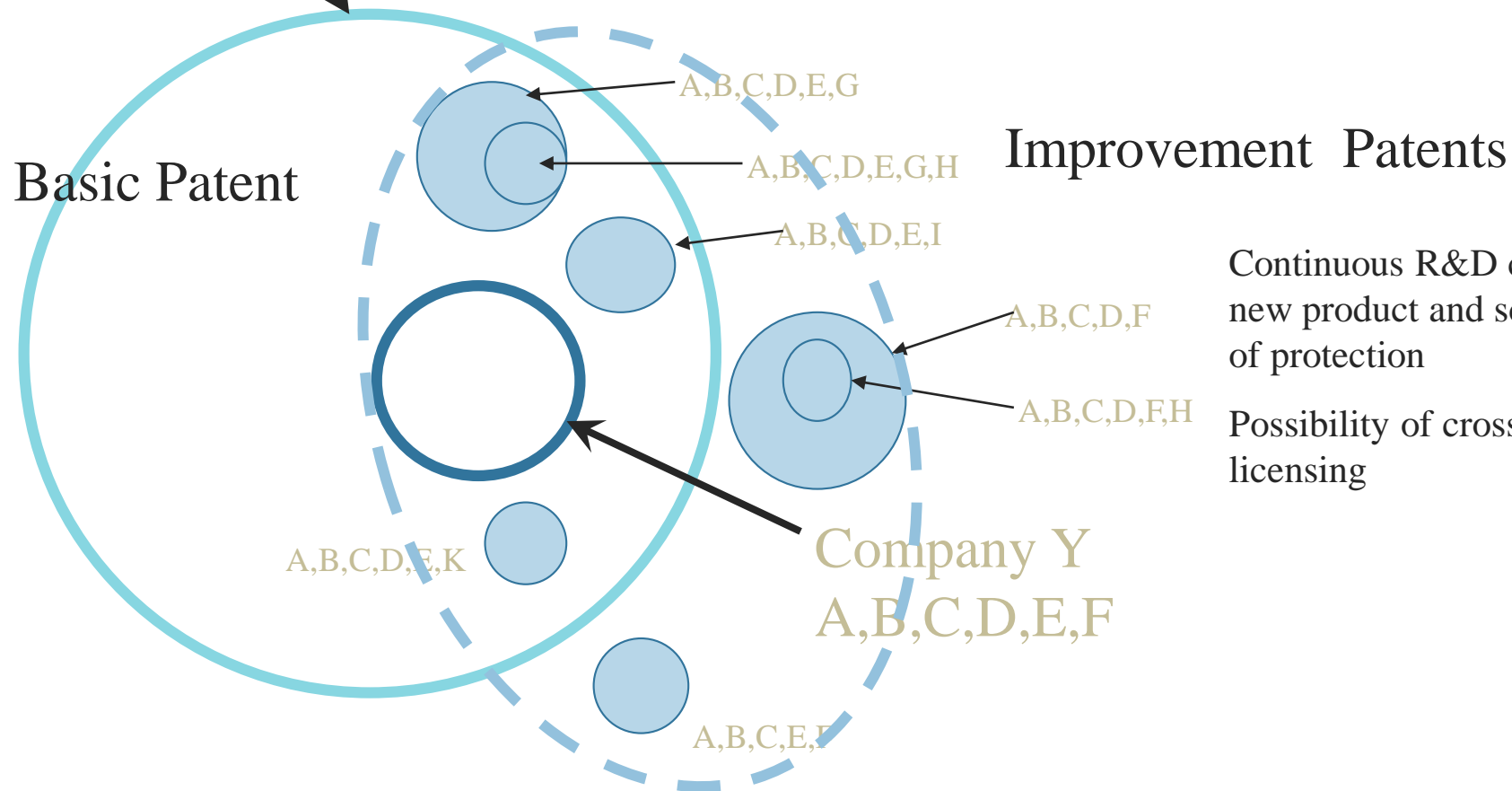
# We can obtain so many technical information through patent information searching

Company X

A,B,C,D,E

Company Y needs licensing from Company X to use the patent No.1

Company X needs licensing from Company Y to use the patent No.2



# Benefits obtained by utilizing patent information

(Utilization by *macro/micro analysis*)

- Acquiring of rich technical information
- Understanding the current technical level
- Technology transition from the past
- Trends in technological innovation
- Trends in alternative technologies
- Activation of invention activities
- Innovation status and evaluation



(Viewpoint of activities by *government*)

- Analyze big data
- Promising technology forecast
- Industrial policy planning
- R & D policy planning
- Improving the capacity of policy groups
- Consulting tools for industry

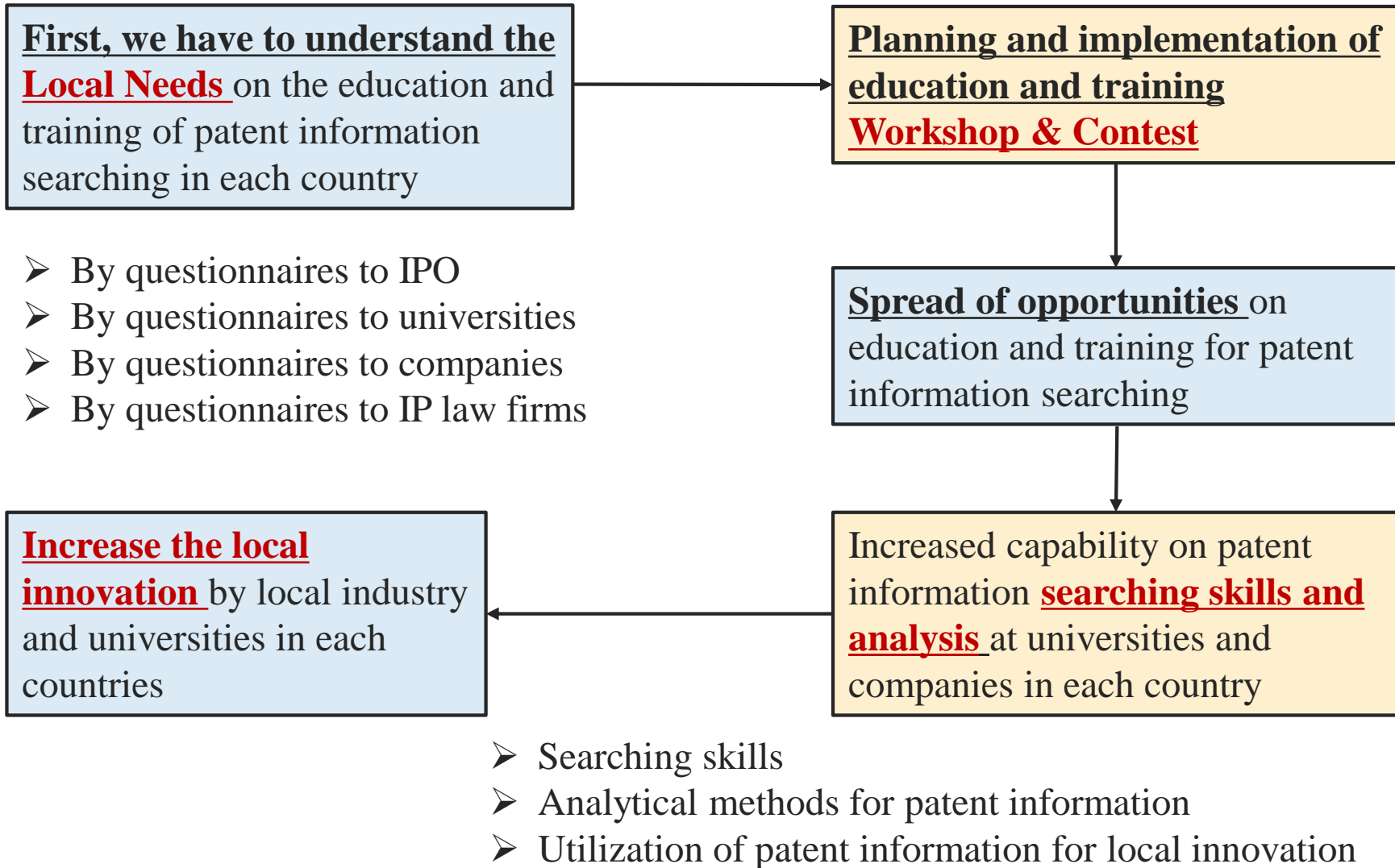
(Improvement of quality by *industry*)

- Trends in patents of our company and other companies
- Corporate technology development/Business growth
- Increase the number of patent applications
- Technology licensing in/out
- Access to the required technology
- Selection of business partners
- Human resource development involved in research and development
- Raise awareness of intellectual property
- Extraction of market needs
- Trends in industry-academia collaboration

(Improvement by *academy*)

- Trends in research themes of universities and research institutes
- From basic research to commercial research
- Practical study for students
- Broaden student's eyes for industry
- Increase the number of patent applications by universities
- Research theme setting
- Bridging between university and industry

# Leadership for patent information searching education



# Overview of Patent Search Workshop and Patent Search Contest

Countries; All ASEAN countries

Participants; Students, Researchers, Practitioners, Companies, IPO officials

Subjects for the workshop;

- “Importance of patent information for industrial development”
- “How to use local IP DB, PatentScope, and other global DB?”
- “Practical demonstration and exercises of patent information searching”

Patent Search Contest;

- Practical understandings on patent information searching through practical experiences
- Motivation up for patent information Searching through contest

Organization for workshop and contest;

- Working team is responsible for preparing workshop and contest
- Coordination and facilitation of workshop and competition

\*Necessary to have help from local expert

What is the driving factors to spread and motivate the education for patent information searching?

We expect to extract the driving factors through workshop and competition.

# How to proceed Contest?

## <Specific Publication No. Searching>

For local publication → Searching by **using IPPlatform or National IPO DB**  
→ Bibliographic data, Abstract → request full document

For foreign publication → Searching by **using WIPO PatentScope, other global DB**

## <Specific Technology Searching>

For local publication → Searching by **using IPPlatform or National IPO DB** → Key words searching on Abstracts (\*local DB with local language)

For foreign publication → Searching by **using WIPO PatentScope, etc.** → Full text search or Abstract search (\*Global DB with English)

\*For the specific technology searching, Key Word Searching is necessary + IPC

\*Necessary to include synonyms key words



# Practical Flow of Contest

1. At the contest, WG provides some **subjects of inventions** for patent information searching
2. **Choose one subject** of invention for searching by participant
3. Understandings on the subject of invention by participants
4. Or, create a virtual invention to be searched, or define the technology to be searched by participants (researchers of university/institute/company)
5. **Define key words** to be used for searching from the subject of invention by participants
6. Carry out **searching process** to get search results by participants
7. Make **reports** in the form and make brief presentation by participants. Report form will be provided by WG.
8. **Evaluate** the submitted reports and search activities by VIPRI and ERIA, and **awarding** to contest winners by VIPRI.

# Example of the inventions provided by ERIA WG

## Proposes examples of inventions to be searched:

Titles of Invention are as follows. The abstracts of these inventions are available in the report form. Participants can choose one invention from the examples.

1. “Glass coating having super repellent performance to the windshield of an automobile”
2. “Removable razor cartridge having magnetic elements”
3. “Method for producing microwave-resistant sheet for heat-insulating foamed paper container”
4. “Writing Instrument”

# Participants' responsibilities

- ✓ Learn the importance on patent information searching, from the workshop.
- ✓ Choose or define one subject of invention for searching contest. (4 subjects of inventions will be distributed.)
- ✓ Carry out key word searching by using IPPlatform and WIPO PatentScope or other global DB.
- ✓ Fill out the reporting form and submit it in the end of Contest. (\*Reporting form will be distributed.)
- ✓ **Brief presentation** on the search results with reflections of workshop and contest.
- ✓ Answers on the questionnaires sheet provided and submit in the end. (\*Questionnaire will be distributed.)
- ✓ VIPRI's responsibility: Final Report shall be sent from VIPRI to ERIA WG

## Attachment 7

### Tool Kit for Patent Information Searching Contest

#### How to coordinate/facilitate Contest?

Prepared by ERIA WG

#### I. Basic Concept of Patent Information Searching

##### <Specific Publication No. Searching>

- (1) In case national IPO (or foreign IPO) sends Office Action to the Applicant, which Patent examiner tells the prior arts with specific publication No., in connection with the reason of refusal.
- (2) In case of receiving warning letter from competitors for patent infringement, together with the specific patent No.

For the above cases, if the patent publications issued by national IPO, we (applicant or business provider) have to check the all bibliographic data and all detailed information by using national IPO DB, or request to have detailed information to national IPO.

If the patents are foreign, we have to check the all related data and document by using WIPO PatentScope or the other global DB.

##### <Specific Technology Searching>

- (1) **In case of filing patent application** to national IPO (or to foreign IPO), we (applicant) have to evaluate the patentability on our invention in advance.

To make technology searching, first we have to define our invention clearly by using technical elements, as a technical combination [A, B, C, D, E].

By specific technology searching using technical key word; simple/multiple key words, IPC,

If we find [A, B, C, D, E], lack of novelty.

If we find some combination like [A, B, C]+[C, D, E], lack of inventive step.

Variation for searching; [A, B, C, D]+[D, E], [A, B]+[B, C, D, E], etc.

- (2) **In case of R&D activities**, we need to make specific technology searching in order to make our R&D activities more efficient.

We expect to have information on,

- ✓ Technology background
- ✓ Technology history
- ✓ Technology roadmap
- ✓ Discrimination against competitors' technology
- ✓ Future development by technical improvement

- ✓ Innovation
- ✓ Technology valuation
- ✓ Licensing strategy
- ✓ Business strategy

## II. How we can understand “Patent Information Searching on Specific Technology”?

Search Results: →group of patent publications; 50, 100, 200, ..., etc.

**We can extract technical features from this search results**, by technical fields, by companies, historical trend, future perspectives, analysis between technology and marketing, etc.

The search results can be provided to different functional organization, and effectively utilized.

- ✓ R&D; future technology, production technology
- ✓ Production; quality and cost control
- ✓ Marketing; Sales/Marketing strategy
- ✓ Business Planning; Business plan
- ✓ Legal; Licensing and contract
- ✓ Human Resource; recruiting and training

## III. How to proceed Contest?

### <Specific Publication No. Searching>

**For domestic publication** → Searching by using national IPO DB → Bibliographic data, Abstract, full document

**For foreign publication** → Searching by using WIPO PatentScope or the other global DB

### <Specific Technology Searching>

**For domestic publication** → Searching by using national IPO DB → Key words searching on the Abstracts or Full text basis (domestic language or English)

**For foreign publication** → Searching by WIPO PatentScope → Full text search or Abstract search (Global DB with English)

For the specific technology searching, **Key Word Searching** is necessary, +IPC

Necessary to include synonyms key words

(1) At the contest, we have to provide some subjects for patent information searching.

**Create a virtual invention and provide the invention to be searched, or define the technology to be searched** (Proposed technology from researchers of university/institute/company)

- (2) Understandings on the subject of invention by participants
- (3) **Define key words** from the invention by participants
- (4) Make **searching process** to **get search results**
- (5) Make reports on the search results and make brief presentation by participants
- (6) Evaluate the search activities and results by national IPO, and provide awards to excellent participants by national IPO.

Example of the inventions provided by ERIA WG

Proposals of inventions to be searched:

Titles of Invention are as follows. The abstracts of these inventions are available at the contest.

Participants can choose one invention from the examples.

- ✓ “Glass coating having super repellent performance to the windshield of an automobile”
- ✓ “Removable razor cartridge having magnetic elements”
- ✓ “Method for producing microwave-resistant sheet for heat-insulating foamed paper container”
- ✓ “Writing Instrument”

\*More detailed explanation materials are available.

## Attachment 8

# Report form of patent information searching contest

ERIA WG  
May 12<sup>th</sup>, 2022

### **Write all answers in English.**

Fill out yourself in the following form.

Name	
Title of your position	
Affiliation	
Email address	

First, answer some of the following questions, before performing a patent information search,

#### Question 1

Discuss the differences of characteristics between academic papers and patent publications.

(Answer less than 200 English words)

#### Question 2

Discuss the importance of utilizing patent information for promoting innovation.

(Answer less than 200 English words)

### Question 3

Discuss the ideal patent information database needed to promote patent information utilization. In particular, discuss the ideal database for patent publications issued in your own country.

(Answer less than 200 English words)

### Question 4

From here, we will ask you to actually perform patent information search and report on the search results. This time, you will be asked to access the patent information database using technical keywords for specific technologies.

First of all, you have to define a specific technology to be searched for patent information. This time, for your convenience, we have prepared the following four technical subjects of inventions. Please read the attached materials of subjects of inventions; 1, 2, 3, and 4. In order to understand what is the invention, it is necessary to understand the problems of the technology to be solved, what kind of technology was adopted to solve the problem,



and the detailed technical explanation. Therefore, the technical subjects of inventions 1, 2, 3, and 4 are explained in these steps in the attachment.

Then, from the above four subjects of inventions, please select one subject that you like and proceed with the following search work to describe the required answer.

Q4-1

Which subject of invention you have selected?

In order to search for patent information that describes this subject of invention, extract the technical keywords (plural) that should be used in the search.

(describe the subject of invention you chose)

(describe some technical key words which shall be used for searching)

Q4-2

To search for patent publications issued in [your country](#) for the selected subject of invention, please access your [IPO DB](#) and enter the technical keywords to perform the keyword search. When entering technical keywords, try to perform multiple key words search in addition to the simple key word search. Please describe the number of patent publications obtained as a result of the search, and also describe the main technical contents described in the obtained patent publications. In addition, please evaluate whether the search results were satisfactory or not. Also, describe the problems you faced on when performing the search.

4-2-1; key word(s) → number of search results

4-2-2; main technical contents described in the obtained patent publications  
(Answer less than 100 English words)

4-2-3; whether the search results were satisfactory or not  
(Answer less than 100 English words)

4-2-4; problems you faced on when performing the search  
(Answer less than 100 English words)

Q4-3

To search for patent publications issued worldwide for the selected technical subject, access the [WIPO PatentScope, Google Patents and other global patent information databases](#), and enter the technical keywords to perform the search. When entering technical keywords, try to perform multiple key words search in addition to the simple key word search. Please describe the number of patent publications obtained as a result of the search, and also describe the main technical contents described in the obtained patent publications. In addition, please evaluate whether the search results were satisfactory or not. Also, describe the problems you faced when performing the search.

4-3-1; key word(s) → number of search results

4-3-2; main technical contents described in the obtained patent publications  
(Answer less than 100 English words)

4-3-3; whether the search results were satisfactory or not  
(Answer less than 100 English words)

4-3-4; problems you faced on when performing the search  
(Answer less than 100 English words)

#### Question 5

As a result of executing this patent information retrieval task, please compare **your IPO DB** and **overseas patent information databases** and describe the advantages and disadvantages of both.

(Answer less than 200 English words)

The above is the work of patent information searching contest that you should do, and the **all answers on questions should be described in this report by the end of contest, and submit it to your IPO administration staff by the end of today's program.**

Your report will be evaluated by your IPO and ERIA WG after the contest, and your presentation on (Date/Month) will be evaluated by your IPO. Then, finally, the winners will be selected and rewarded later on the other day, 2022.

We hope that your positive and active efforts will be really appreciated, producing the valuable results.

Thank you very much for your participation today with your big contributions.

# Information and instruction of invention business contest

June 8<sup>th</sup>, 2023

Yoshitoshi Tanaka

ERIA WG Leader

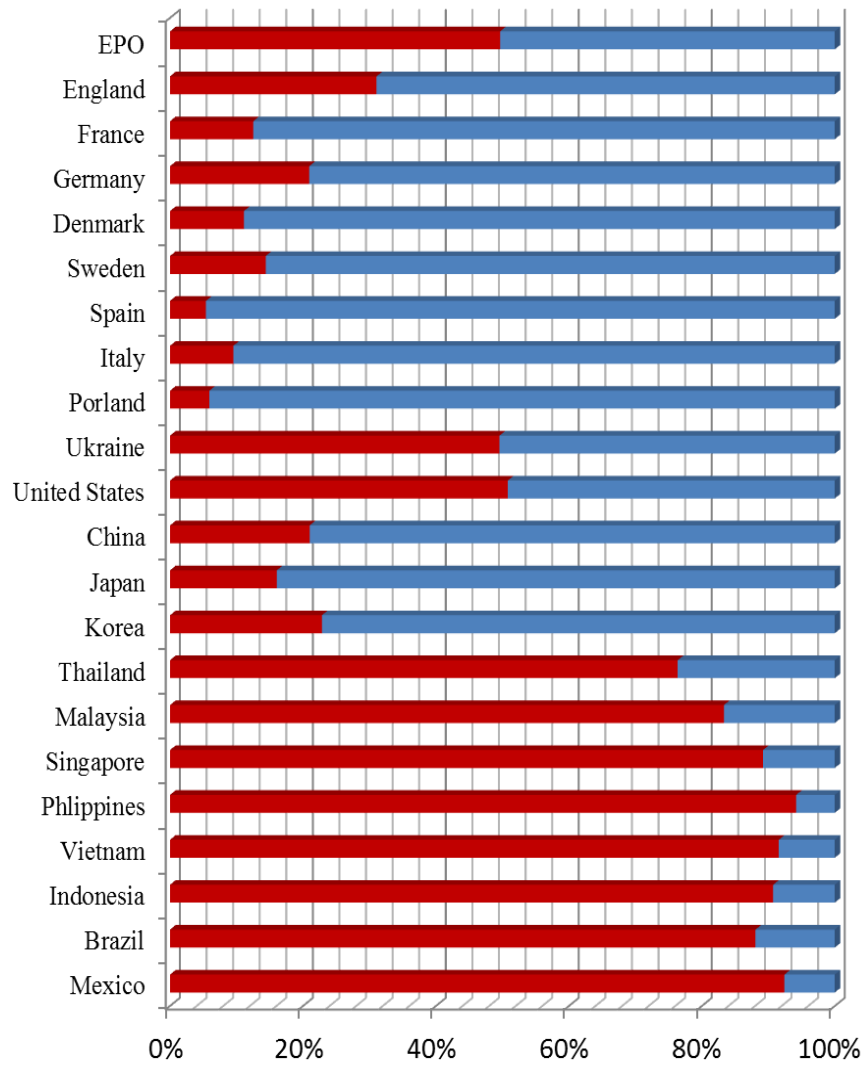
Professor Emeritus, Tokyo Institute of Technology

# Number of patent applications in each country

## Resident and Non-Resident

Europe

EPO



■ Non-Resident  
■ Resident

US

Asia  
S. America

Asian initiative for further growth

Data : World Intellectual Property Organization (WIPO)

# Discussions on “Resident” and “Non-resident”

Patent applications of global basis  
Residents; 69 %  
Non-residents; 31 %  
Patent registrations of global basis  
Residents; 61 %  
Non-residents; 39 %

On a global basis, “Residents” account for 60% to 70% of both patent applications and patent registrations. That is, it can be seen that Residents are dominant.

So what does the ratio of Residents and Non-residents indicate?

This is a very important point for how we understand the global society and the advantage of intellectual property. Furthermore, by looking at the situation within each country, you can understand the **level of superiority of Residents** in your country.

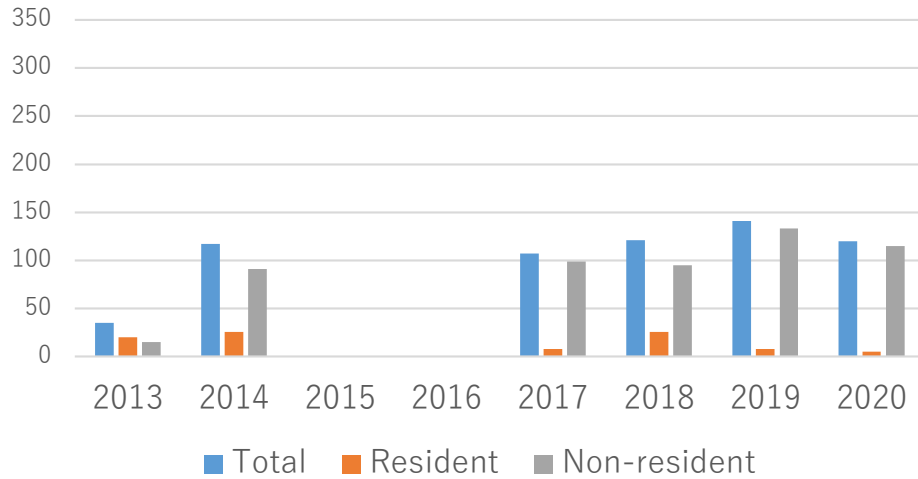
Now, let's see our situation of  
residents and non-residents  
applications!



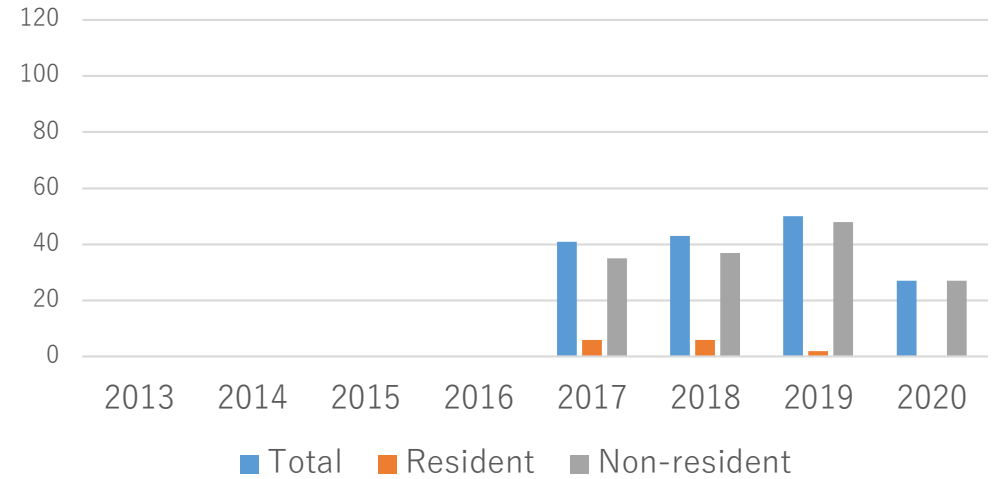
# Patent Applications & Registrations

Source; WIPO Statistics

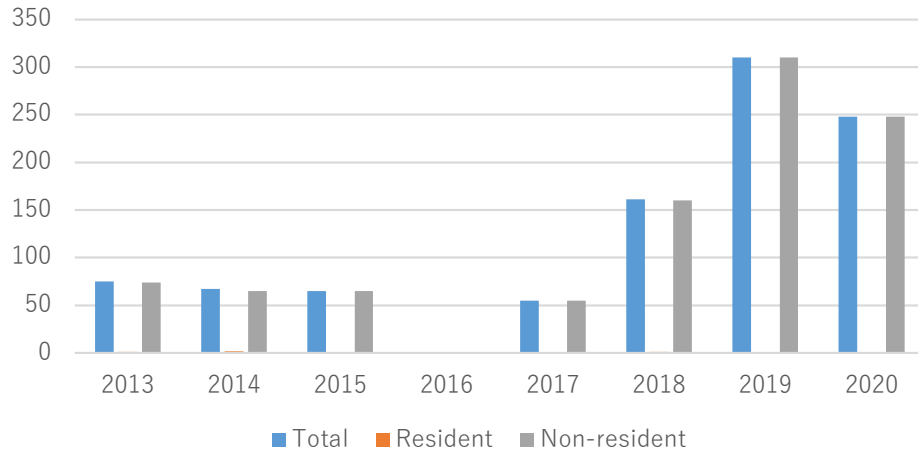
## Patent Applications in Brunei



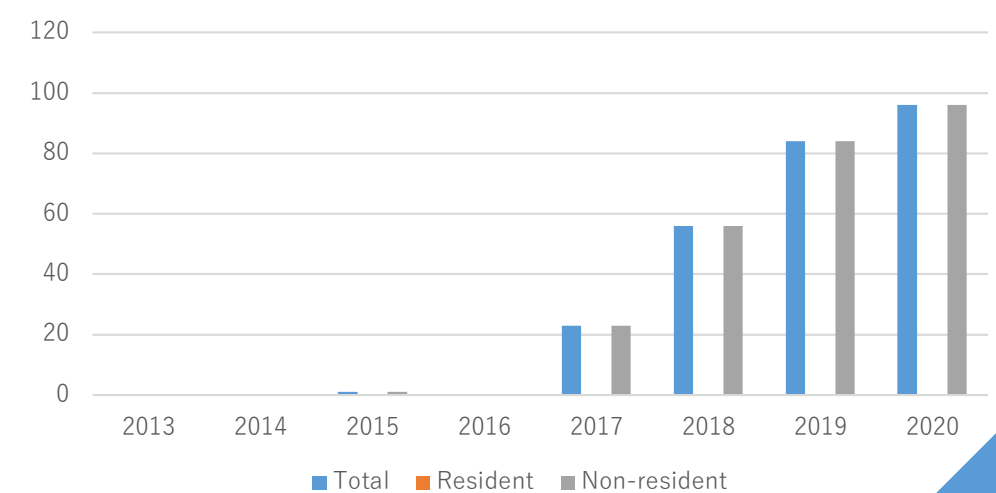
## Patent Registrations in Brunei



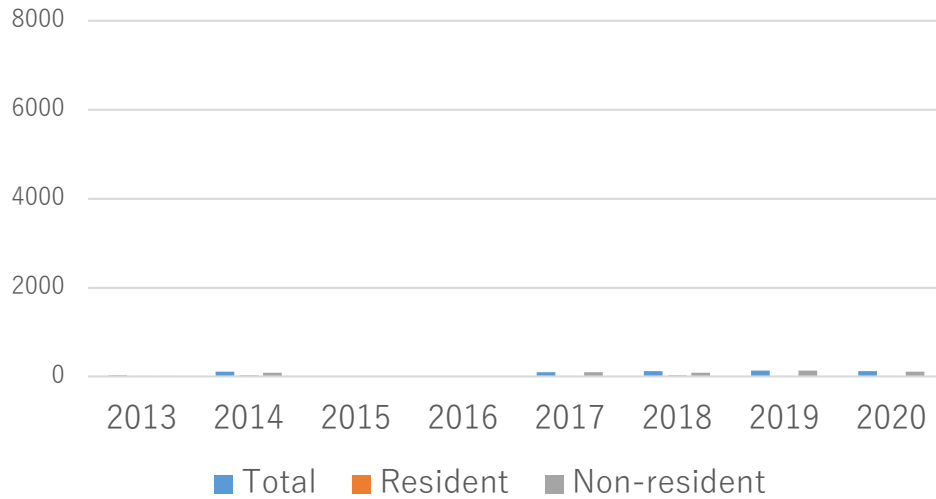
## Patent Applications in Cambodia



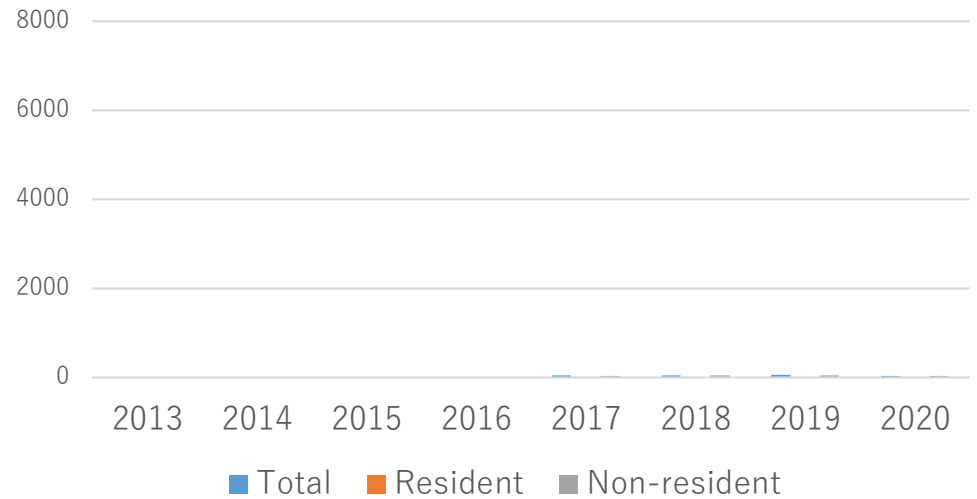
## Patent Registrations in Cambodia



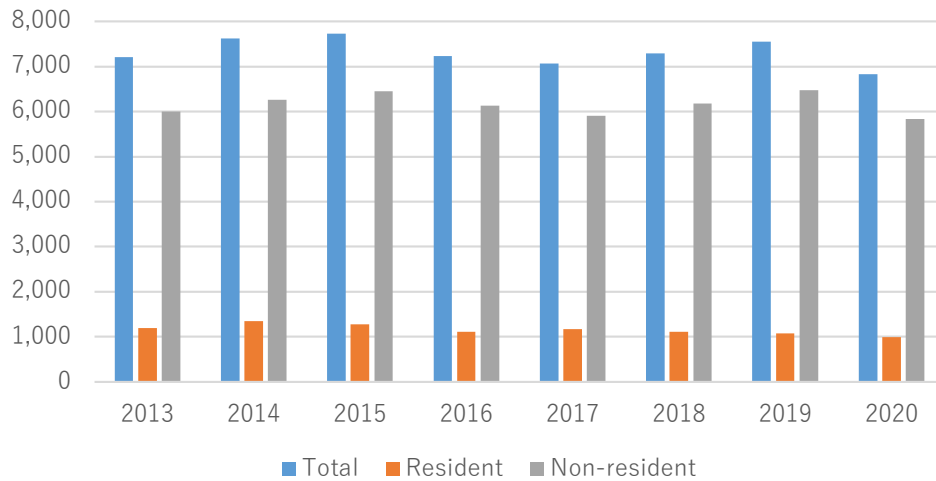
Patent Applications in Brunei



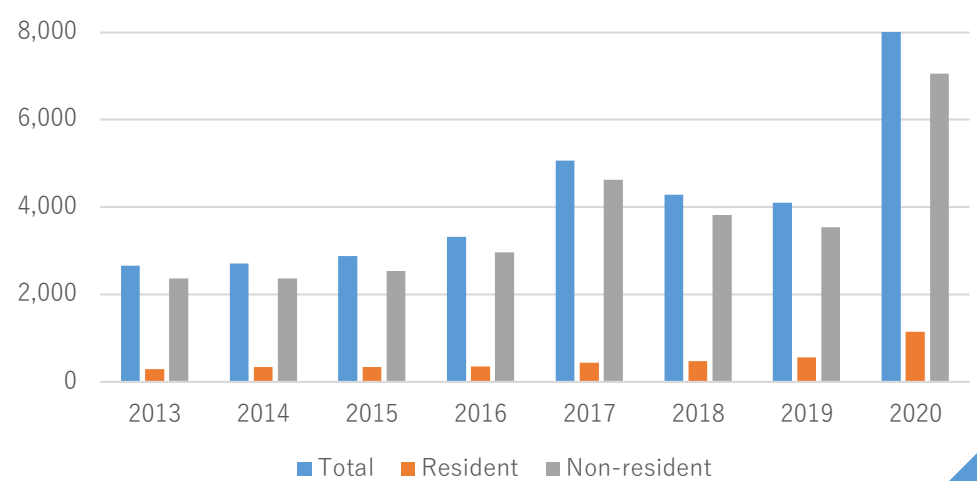
Patent Registrations in Brunei



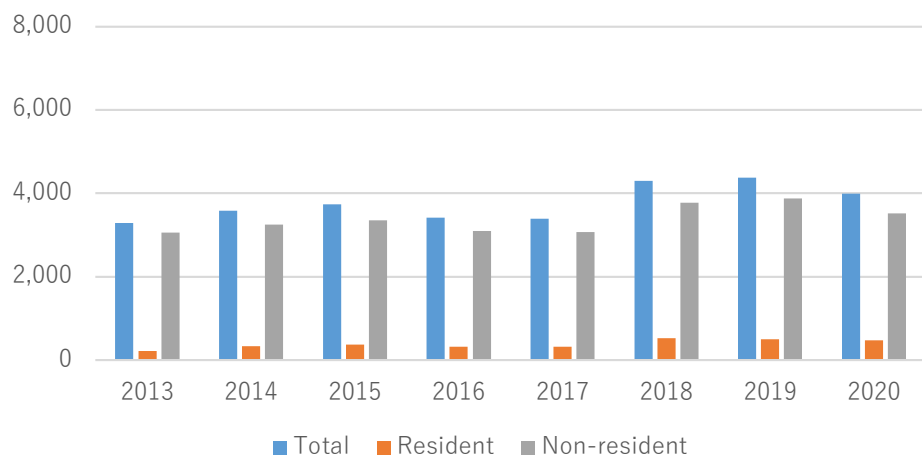
Patent Applications in Malaysia



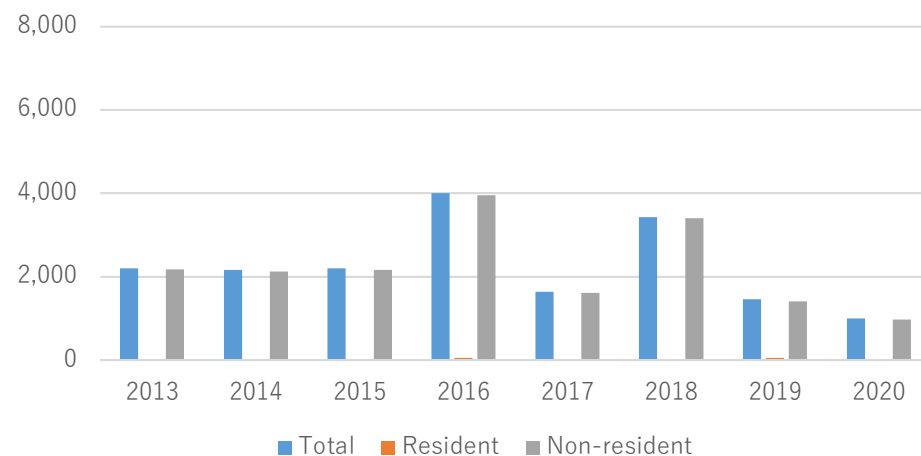
Patent Registrations in Malaysia



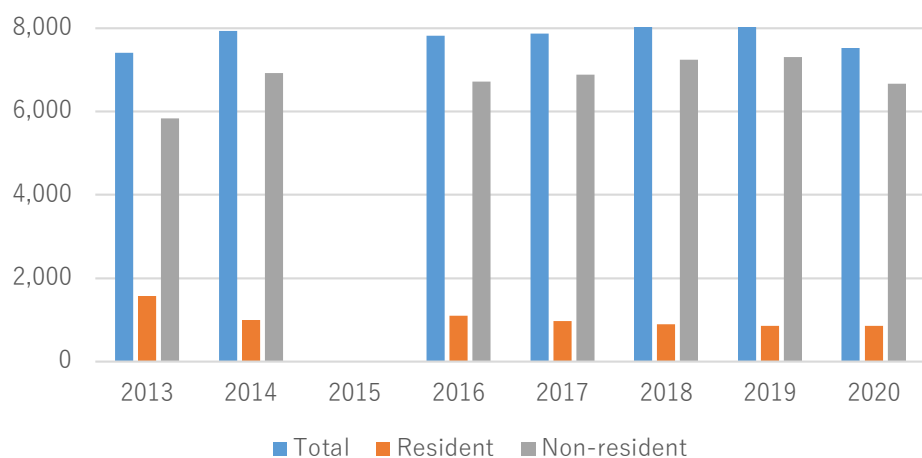
### Patent Applications in Philippines



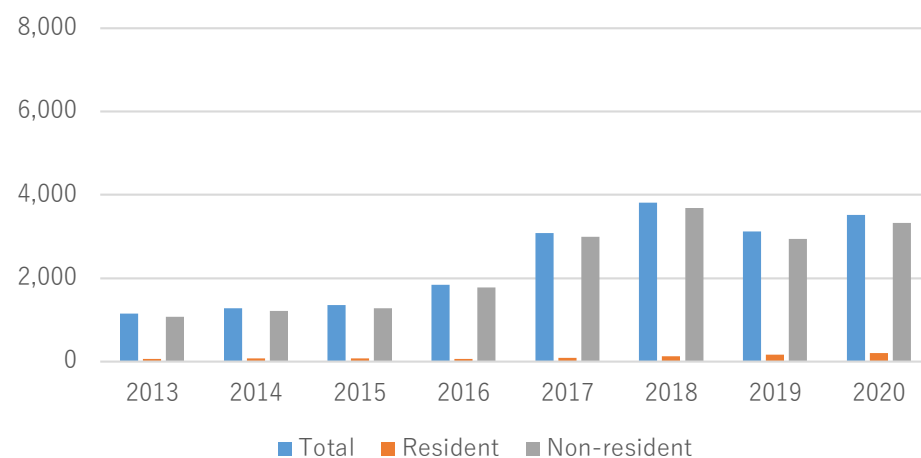
### Patent Registrations in Philippines



### Patent Applications in Thailand



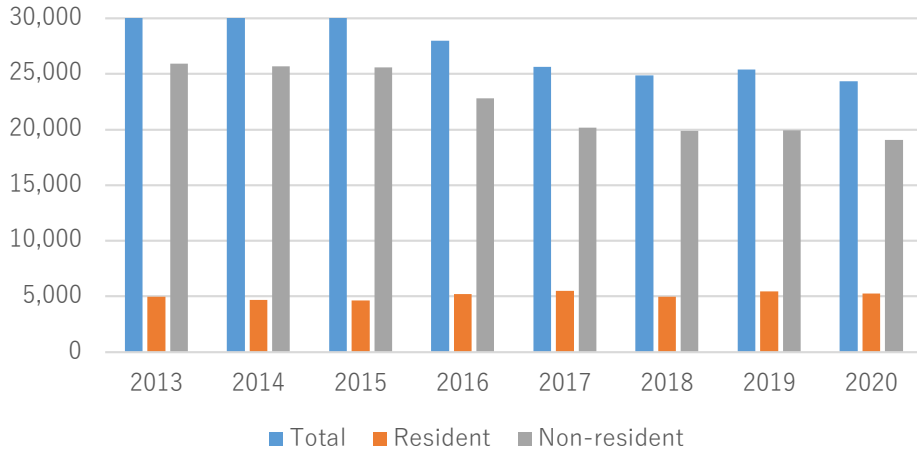
### Patent Registrations in Thailand



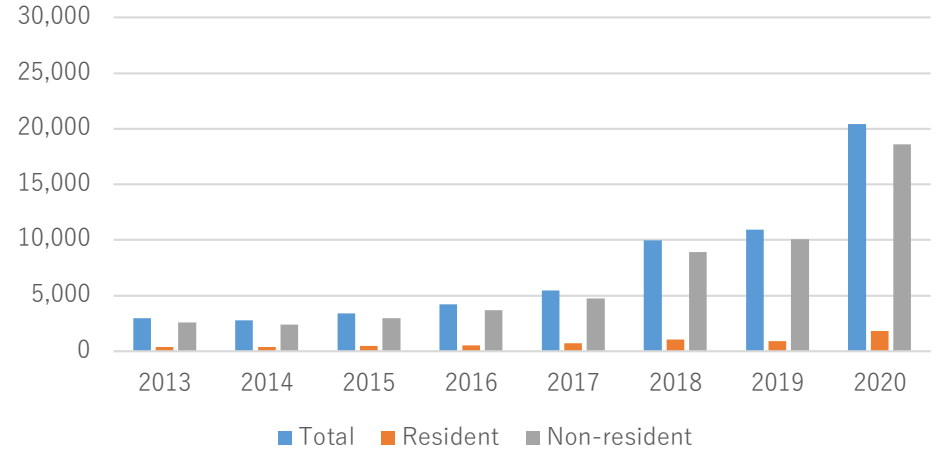
# Patent Applications & Registrations

Source; WIPO Statistics

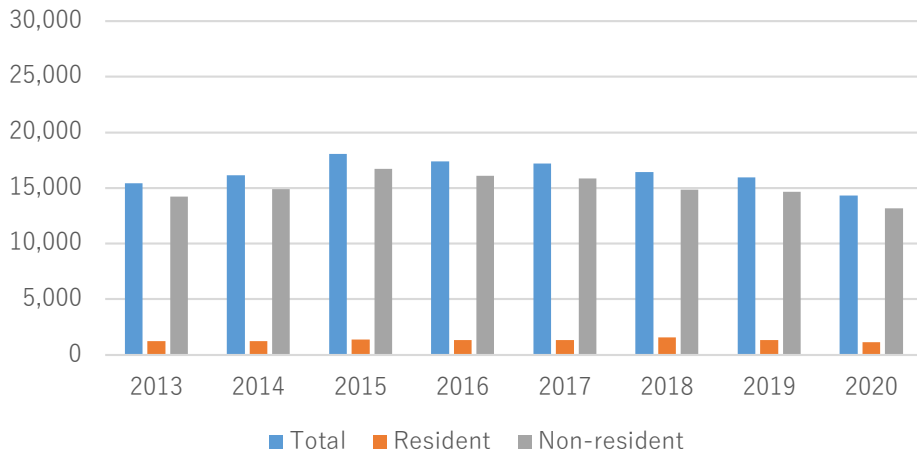
## Patent Applications in Brazil



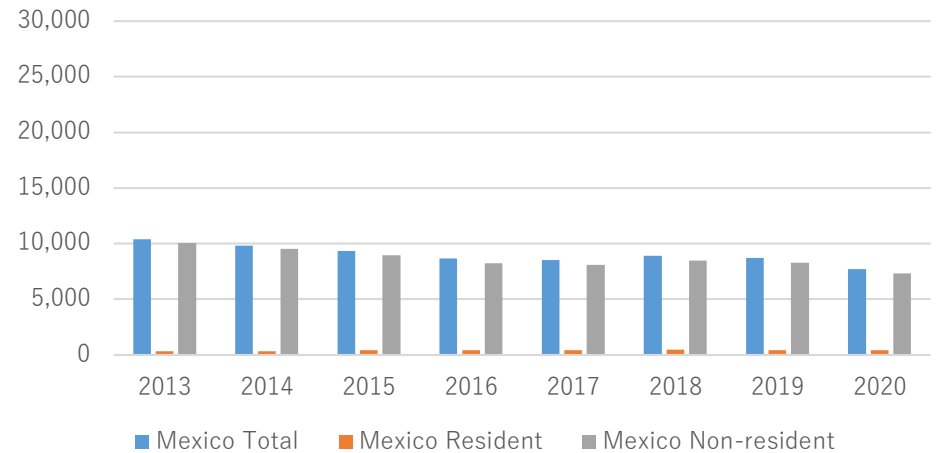
## Patent Registrations in Brazil



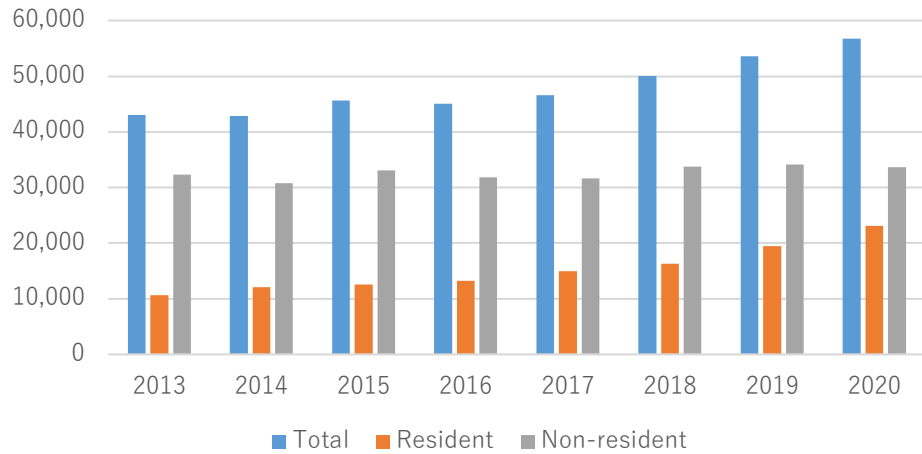
## Patent Applications in Mexico



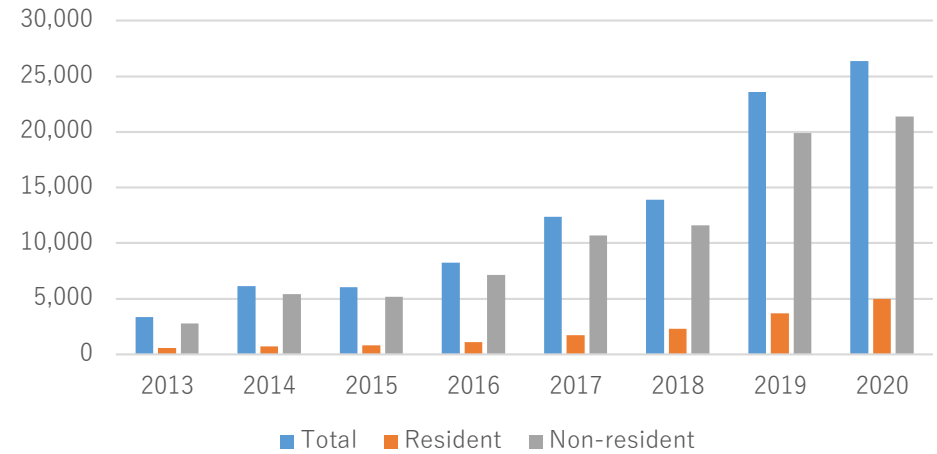
## Patent Registrations in Mexico



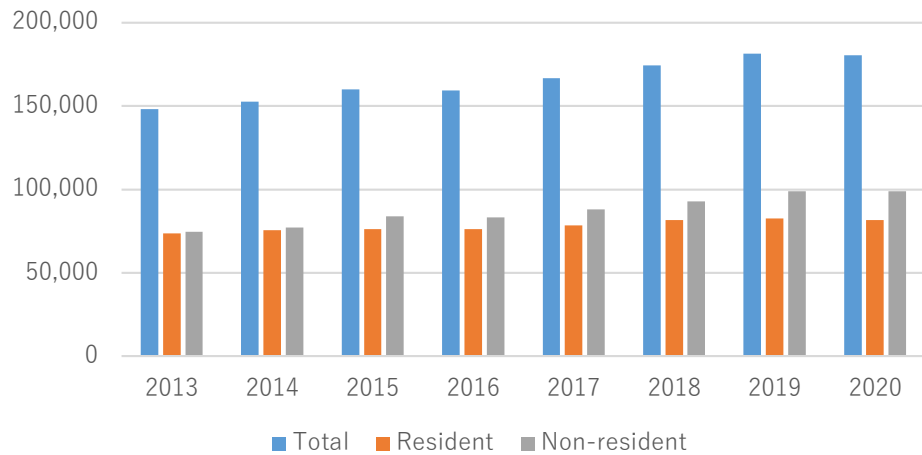
### Patent Applications in India



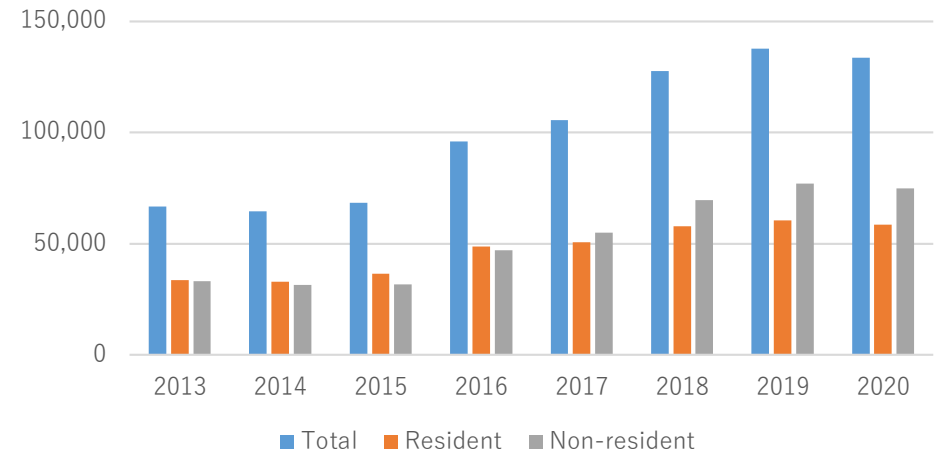
### Patent Registrations in India



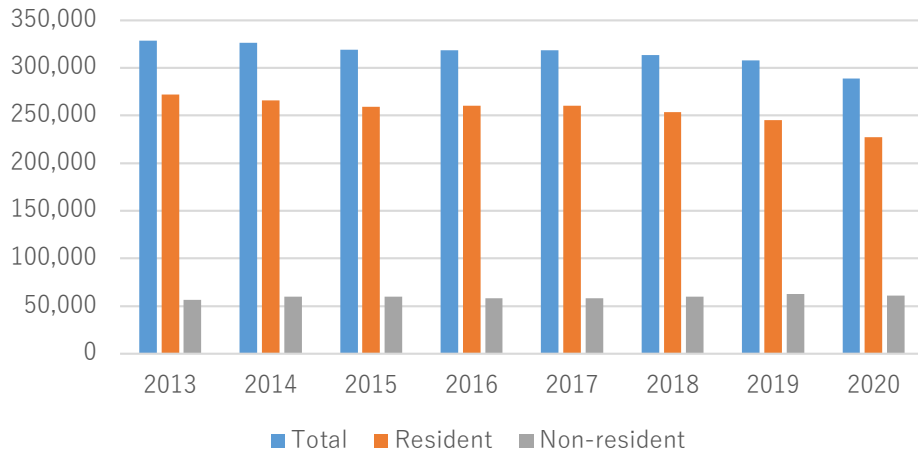
### Patent Applications in EPO



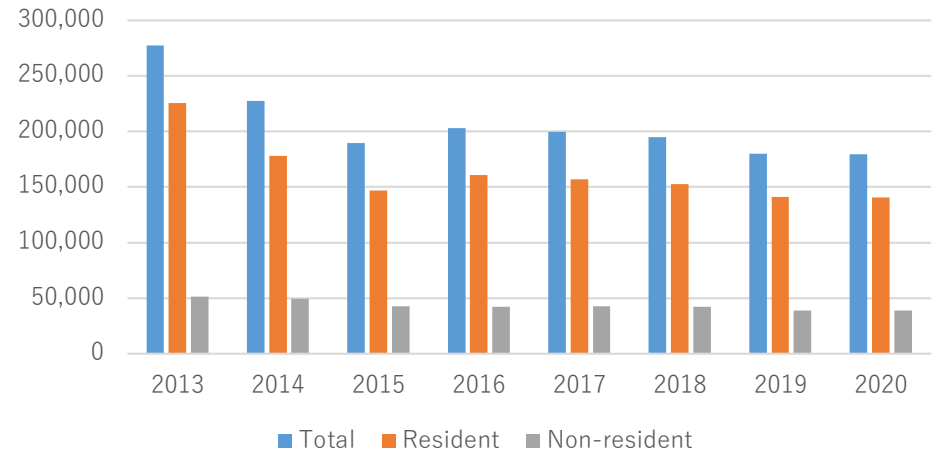
### Patent Registrations in EPO



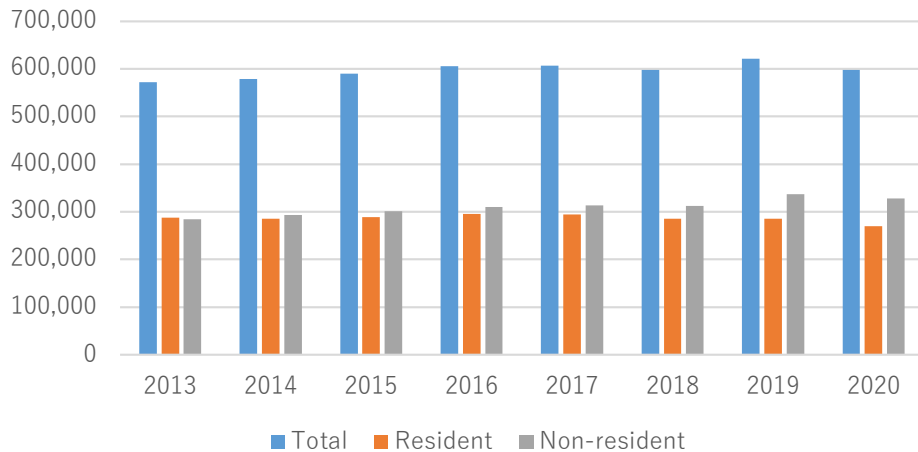
Patent Applications in Japan



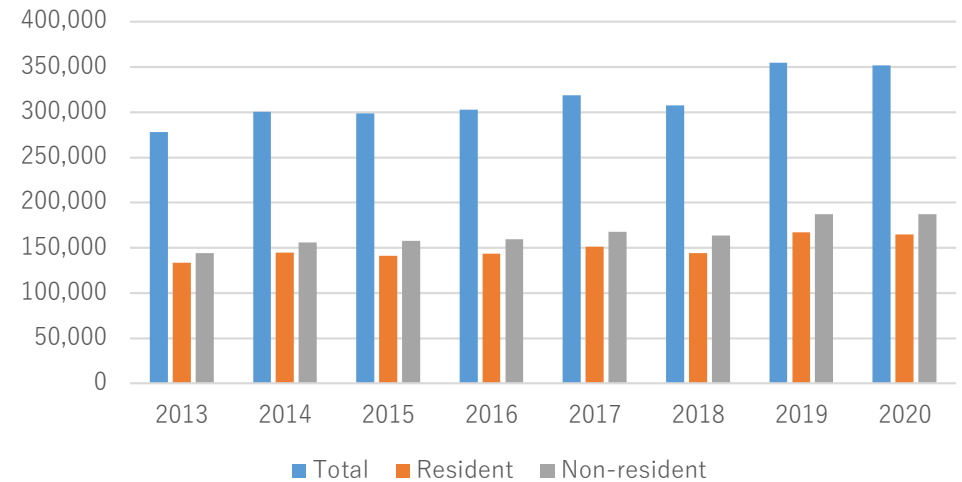
Patent Registrations in Japan



Patent Applications in the US

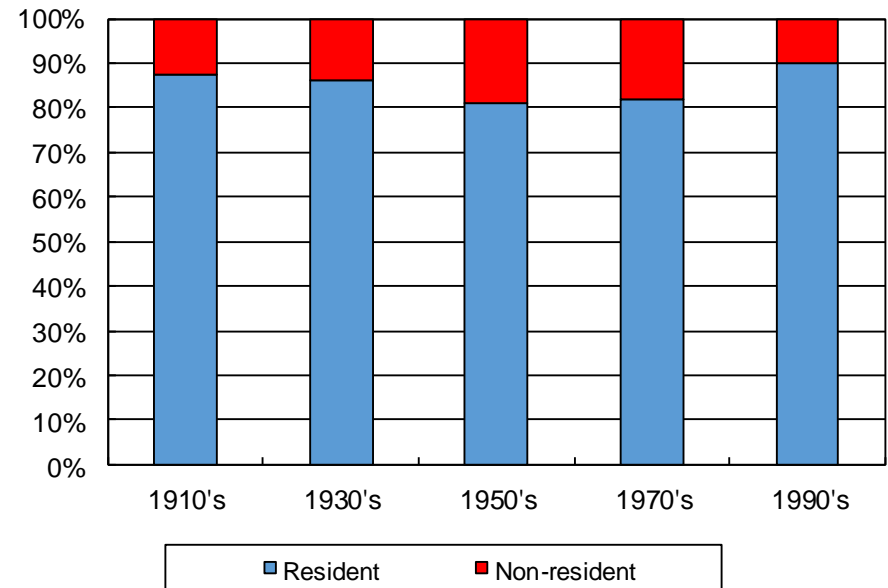
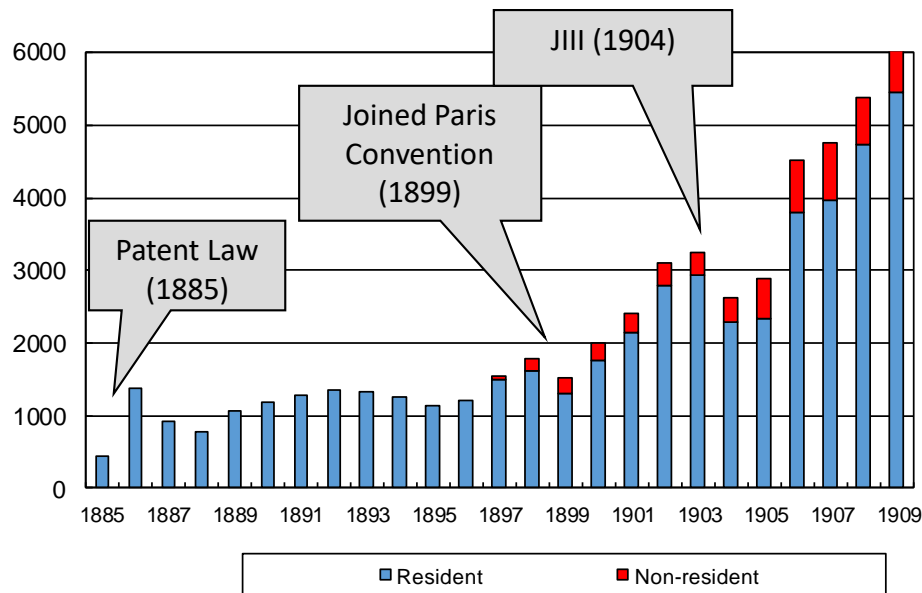


Patent Registrations in the US



# Resident/non-resident in Japan

Japan's patent applications have always been over 80% by residents since 1885 when the patent system was started.



# Two-way Socket



A small company started in 1918 with only 3 people

SME

Started from Intellectual Property Rights

Huge amount of profit and started its rapid expansion



Global Enterprise for  
Electrical Products  
**Panasonic**

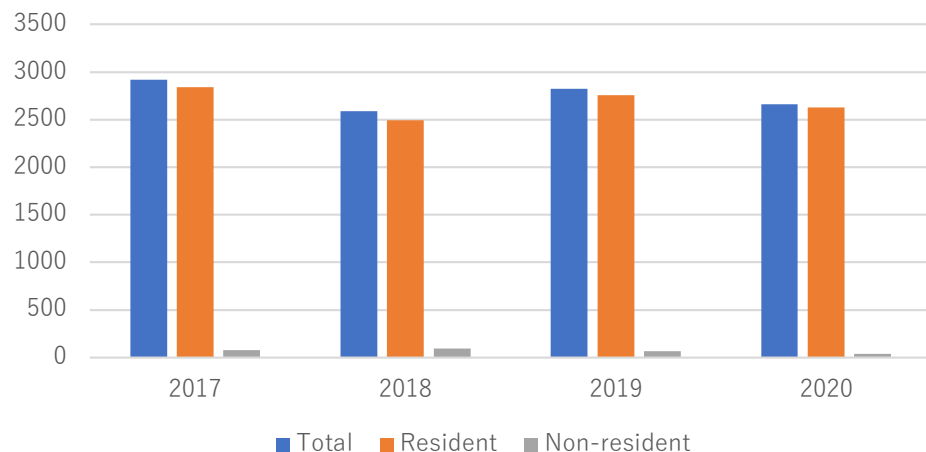
Mr. Konosuke Matsushita obtained Utility Model registrations in 1919.



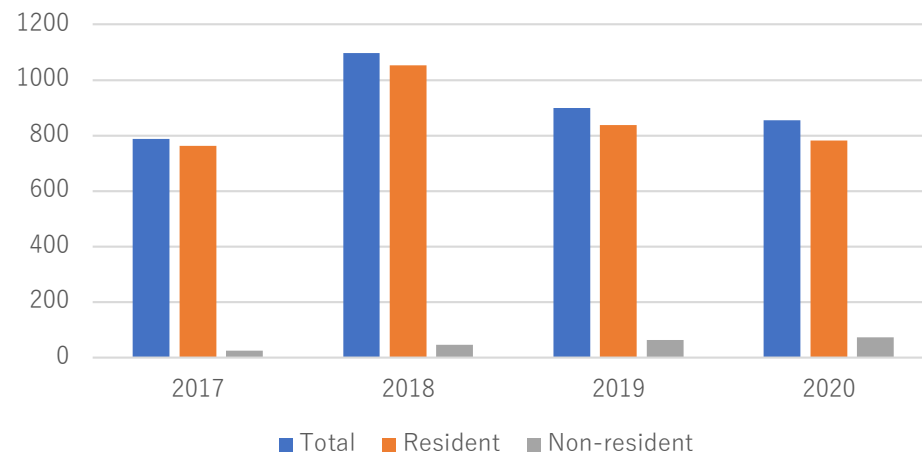
# Utility Model Applications & Registrations

Source; WIPO Statistics

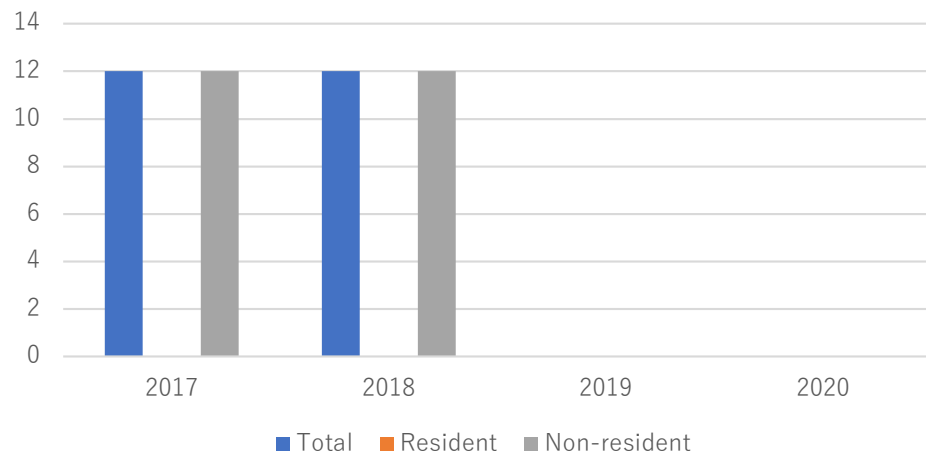
## UM applications in Brazil



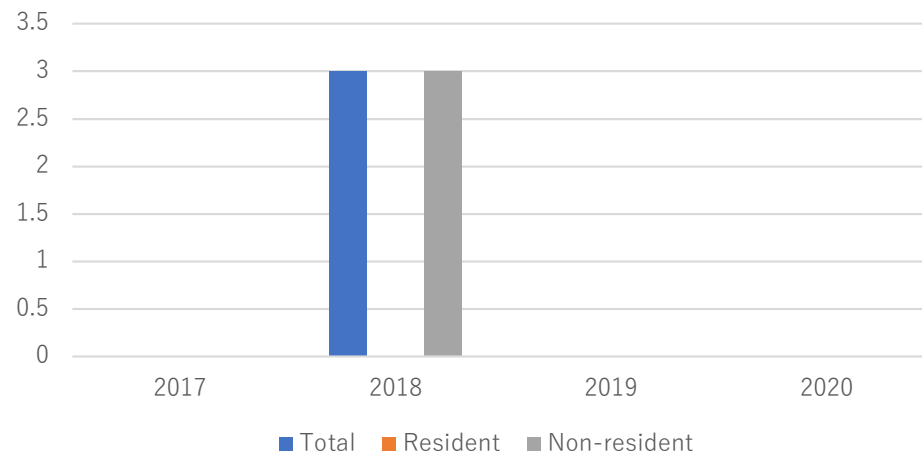
## UM registrations in Brazil



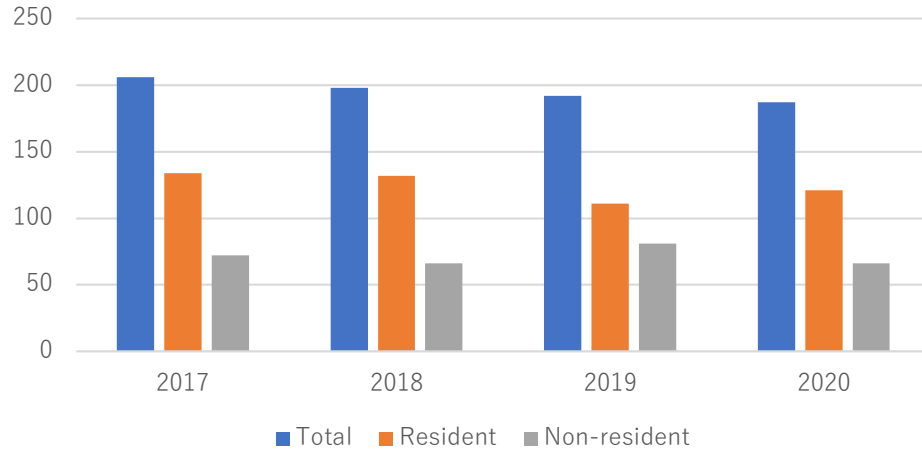
## UM applications in Cambodia



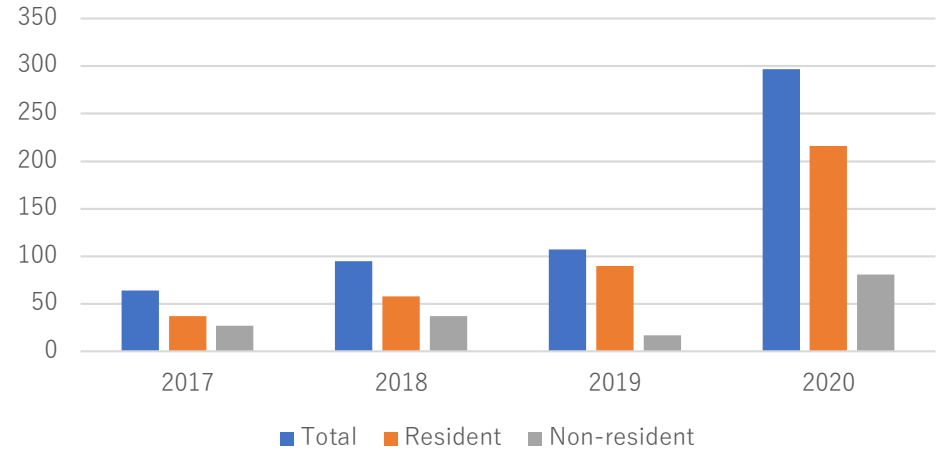
## UM registrations in Cambodia



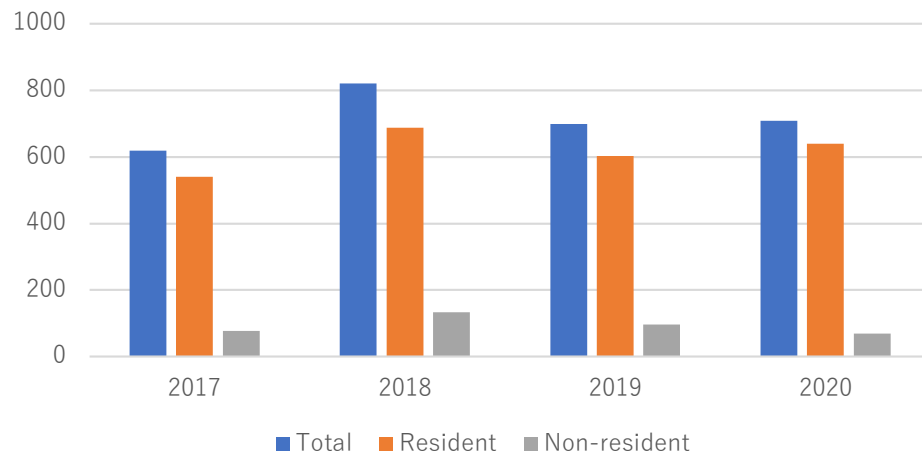
UM Applications in Malaysia



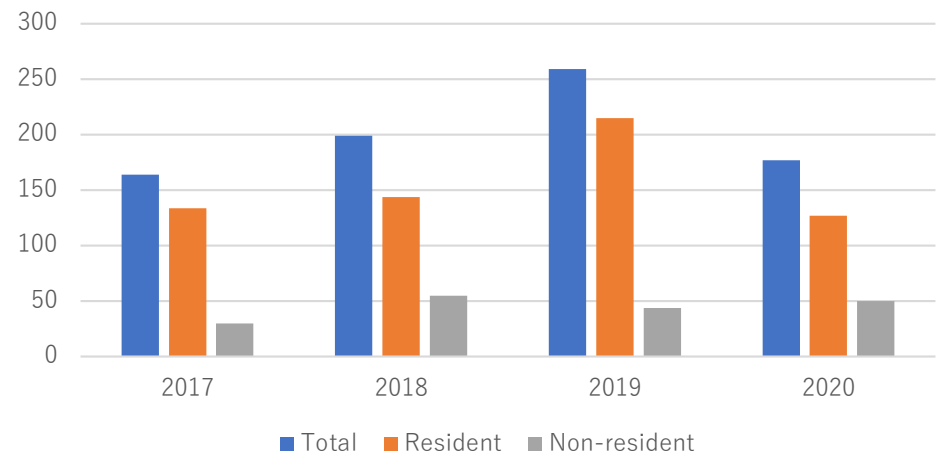
UM registrations in Malaysia



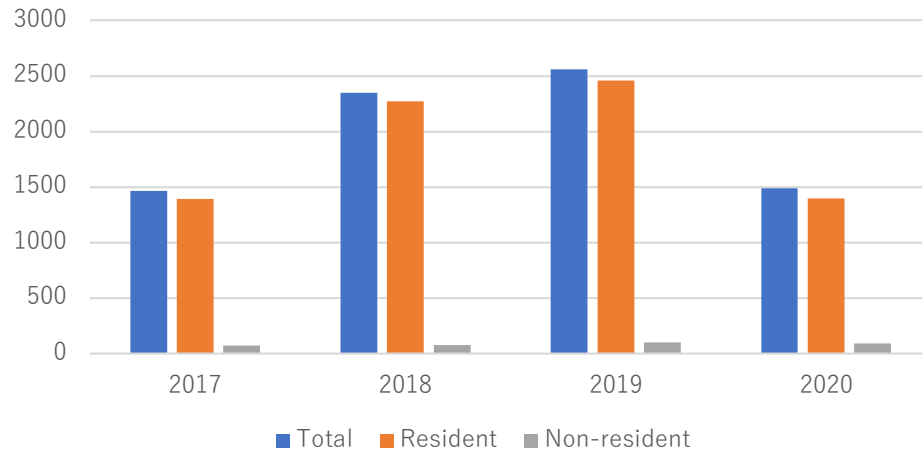
UM applications in Mexico



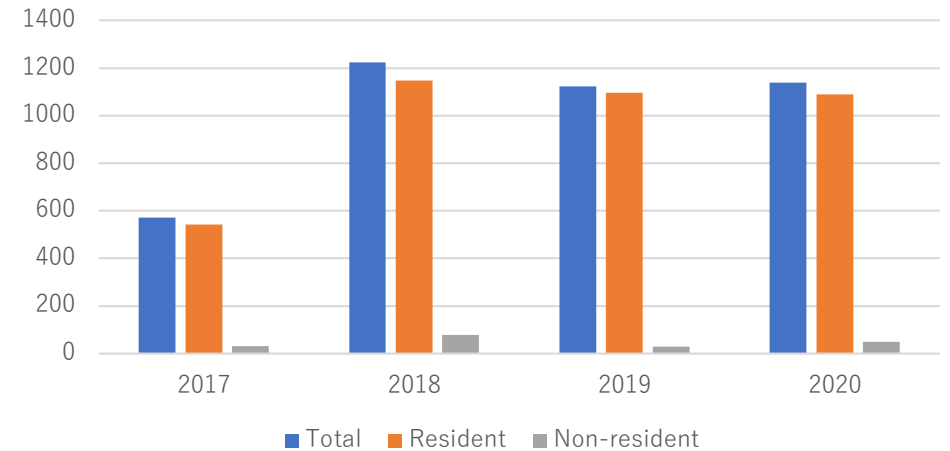
UM registrations in Mexico



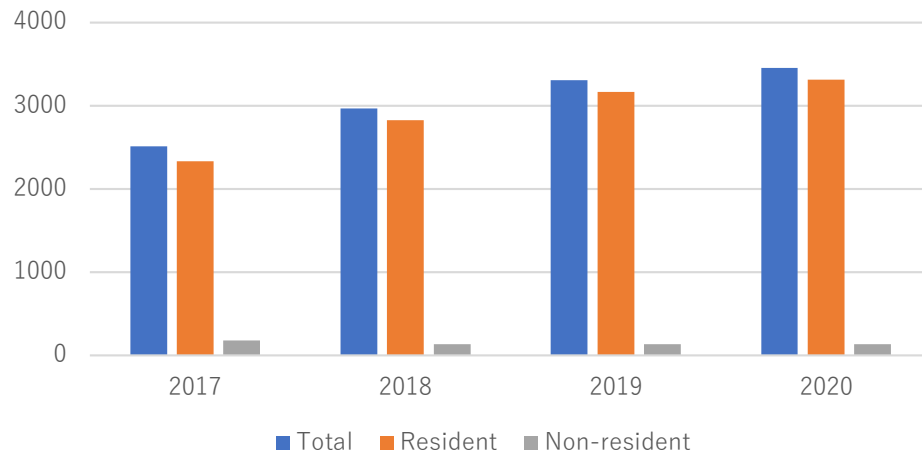
UM applications in Philippines



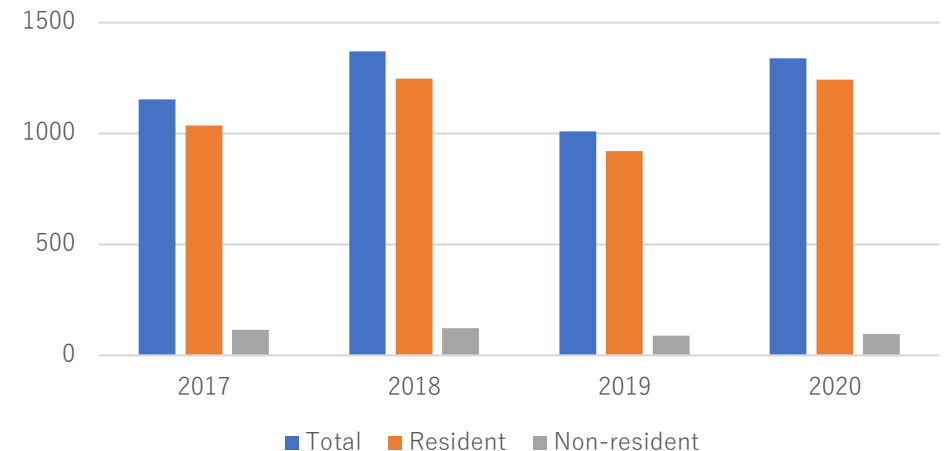
UM registrations in Philippines



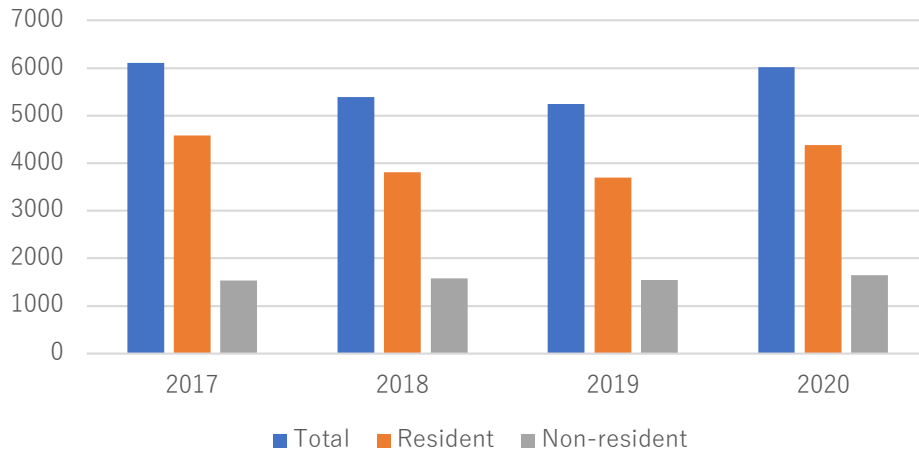
UM applications in Thailand



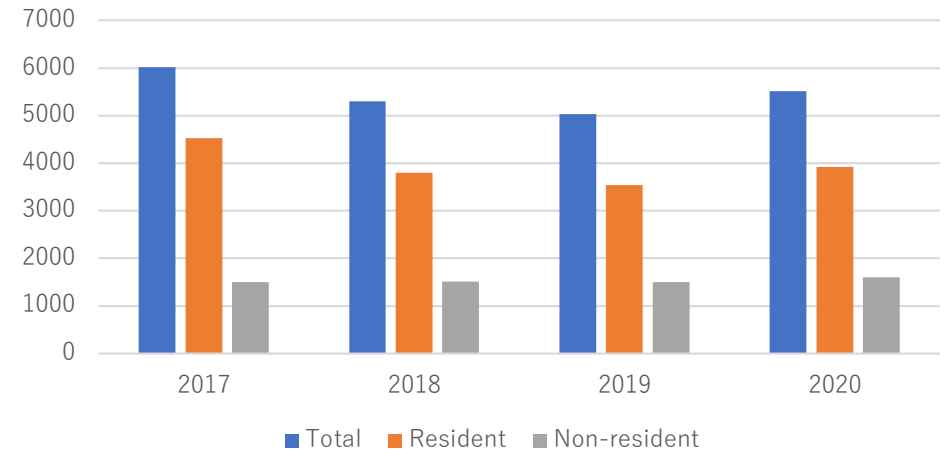
UM registrations in Thailand



UM applications in Japan



UM registrations in Japan



Only 2 % of the number of patent applications.

## Importance of Industrial Design

There are various factors when choosing a product, but good design is a big factor. One of the selling points of many hit products is their high design.



There are many industrial products around us, but excellent industrial products have an appearance that appeals to human senses and excellent functionality.

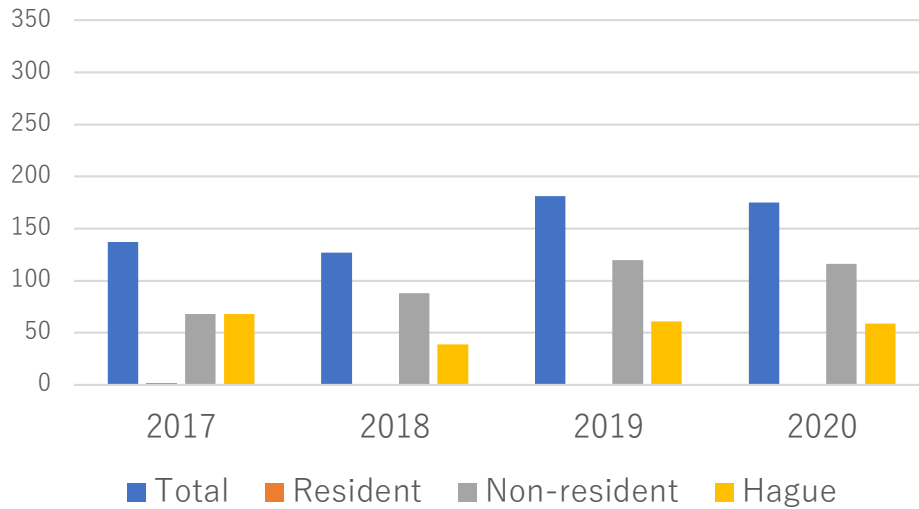
The original purpose of industrial design is not simply to improve the appearance of products, but to realize the functions, usability, and comfort of products based on human senses.

In other words, the mission of industrial design is to pursue products that are highly compatible with both functionality and design value, and to respond to diversifying needs. Big impacts on the sales and marketing of the products.

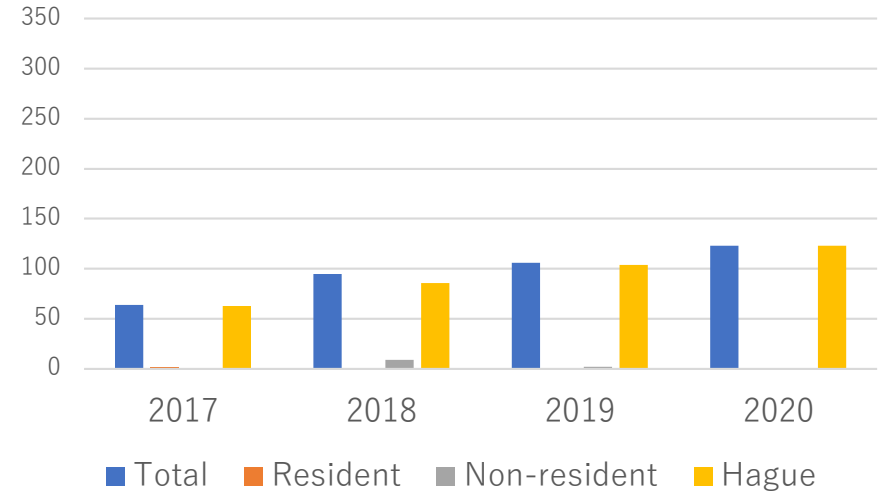
# Industrial Design Applications & Registrations

Source; WIPO Statistics

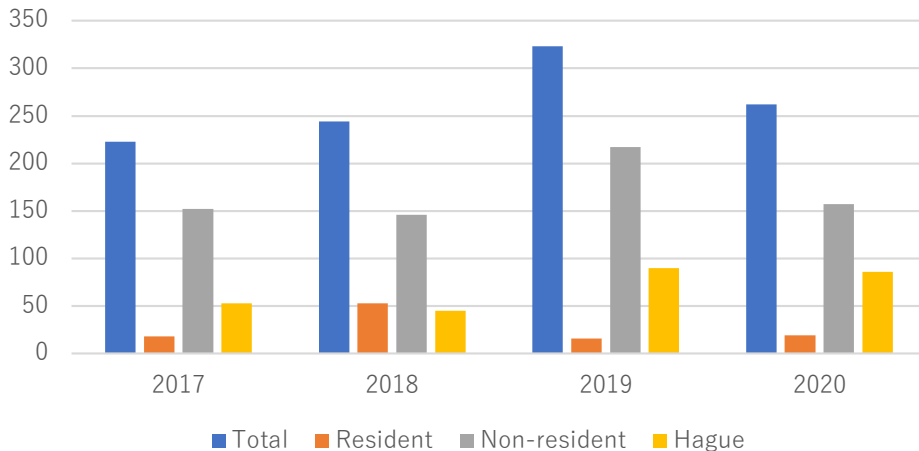
## ID Applications in Brunei



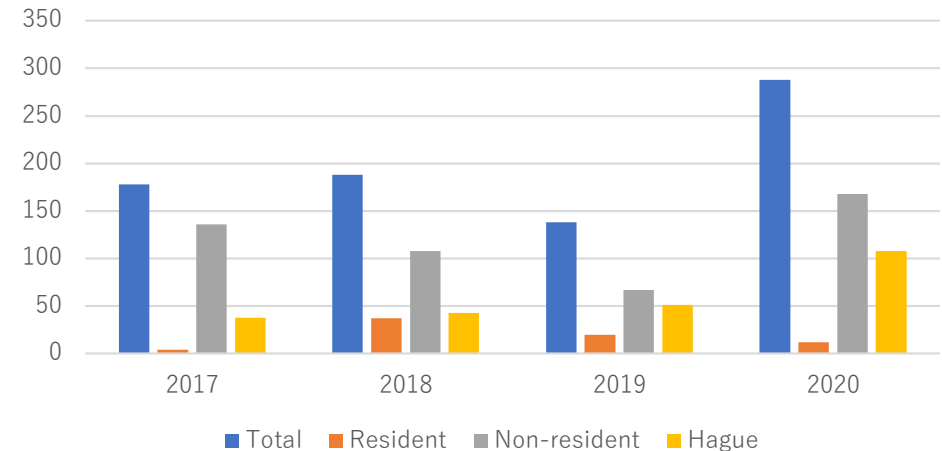
## ID Registrations in Brunei



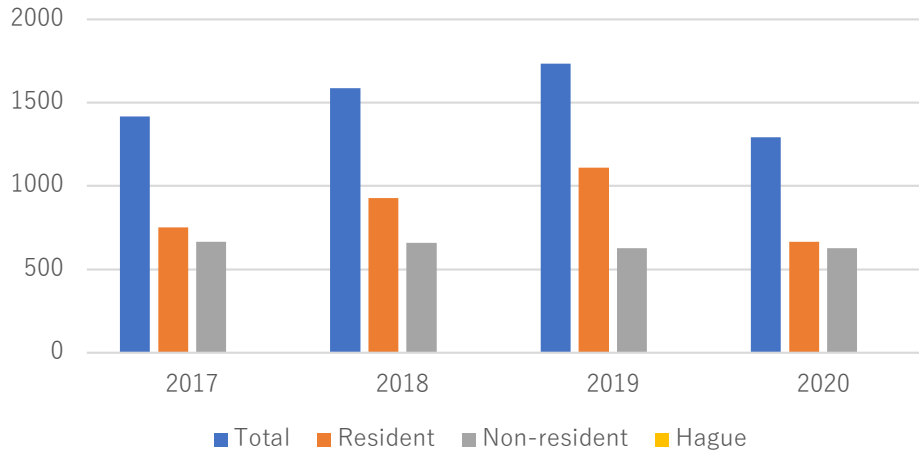
## ID applications in Cambodia



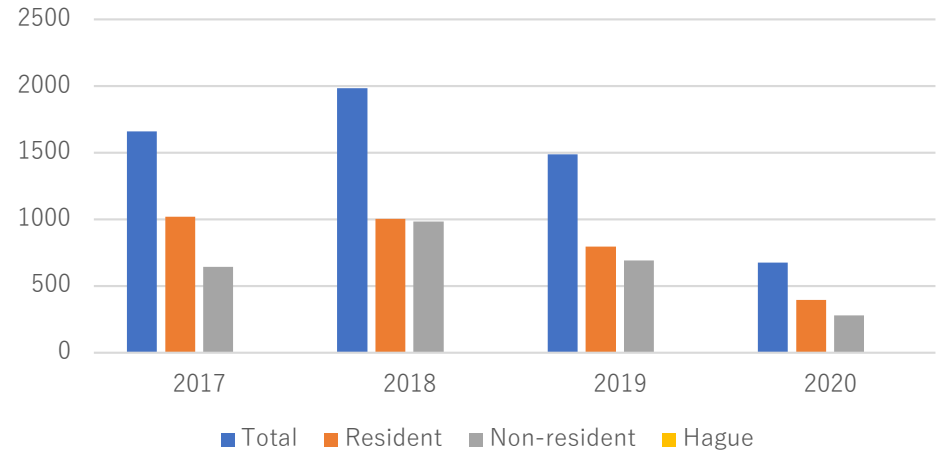
## ID registrations in Cambodia



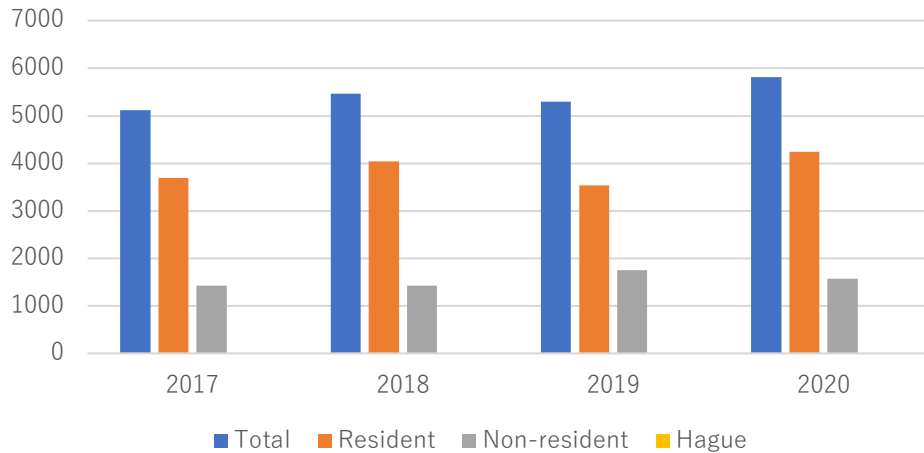
ID applications in Philippines



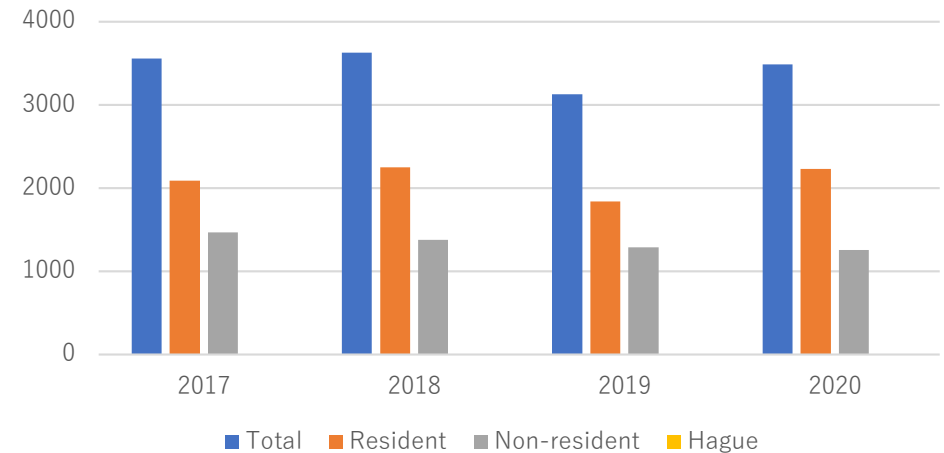
ID registrations in Philippines



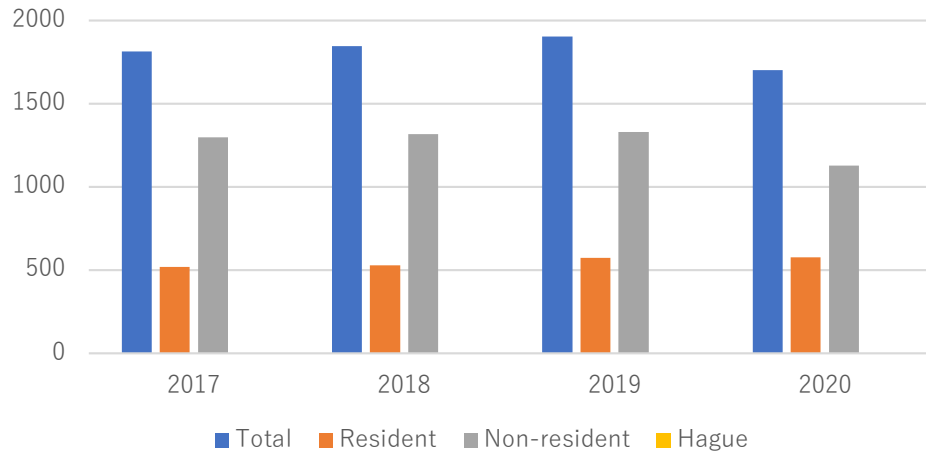
ID applications in Thailand



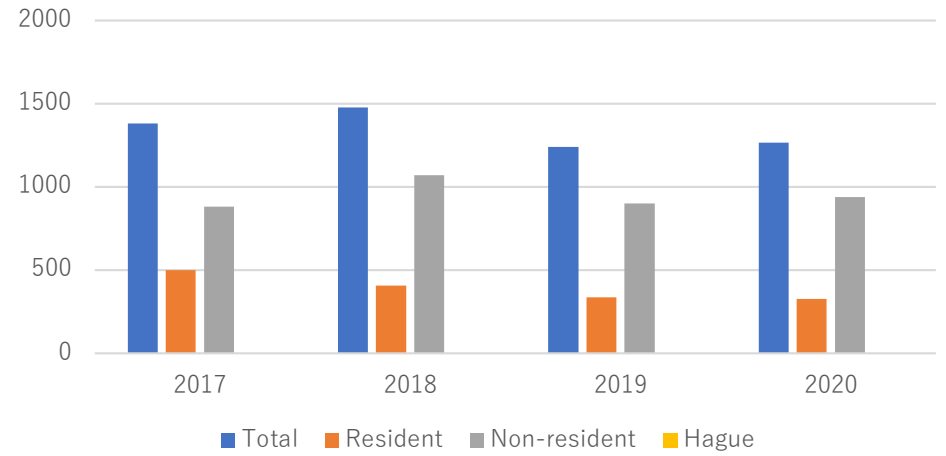
ID registrations in Thailand



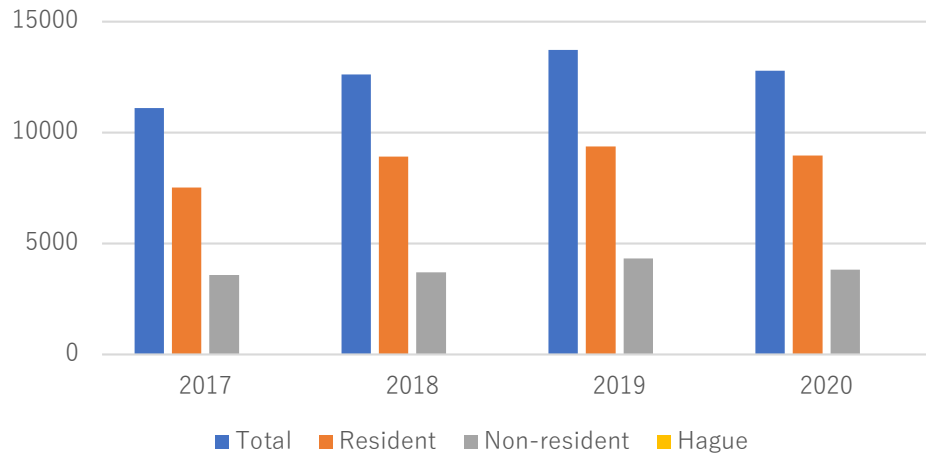
ID applications in Malaysia



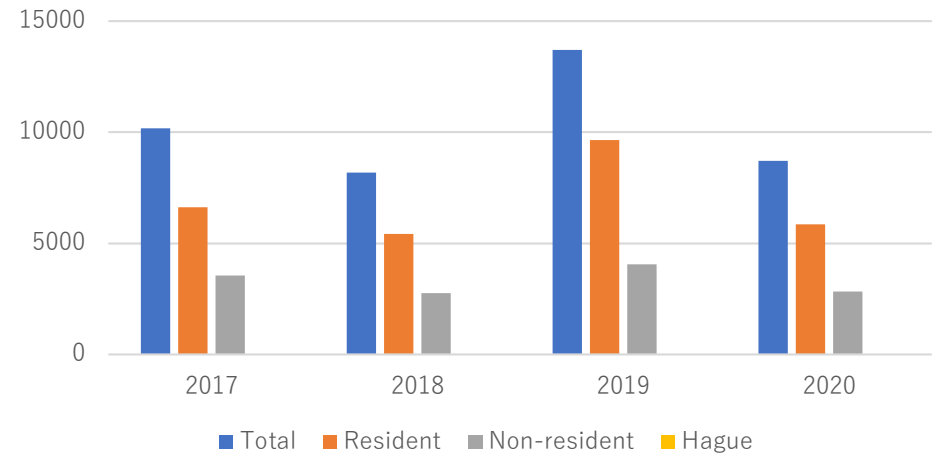
ID registrations in Malaysia



ID applications in India

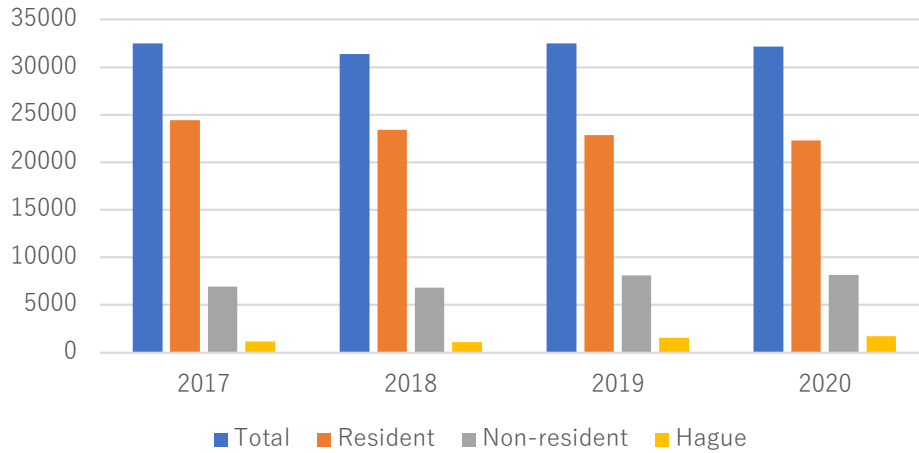


ID registrations in India

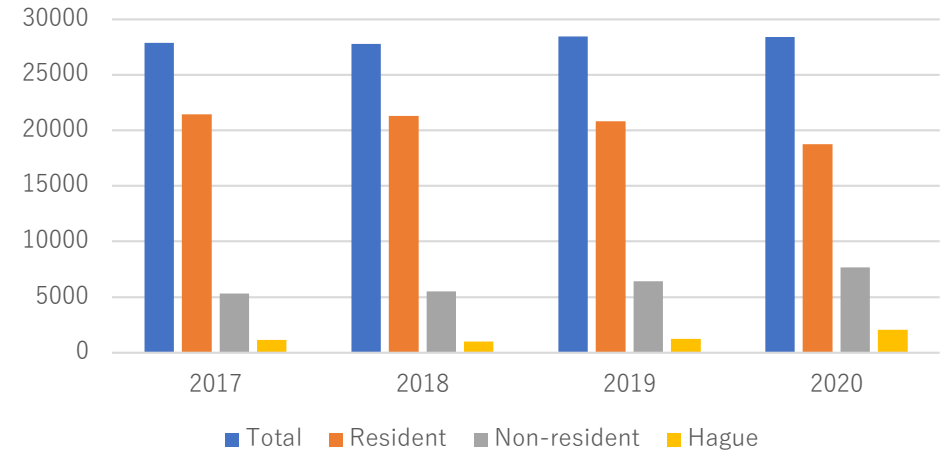




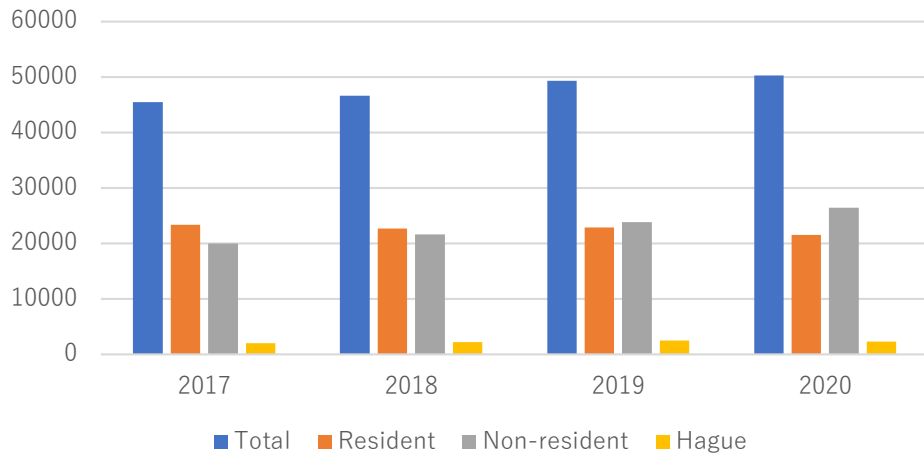
ID applications in Japan



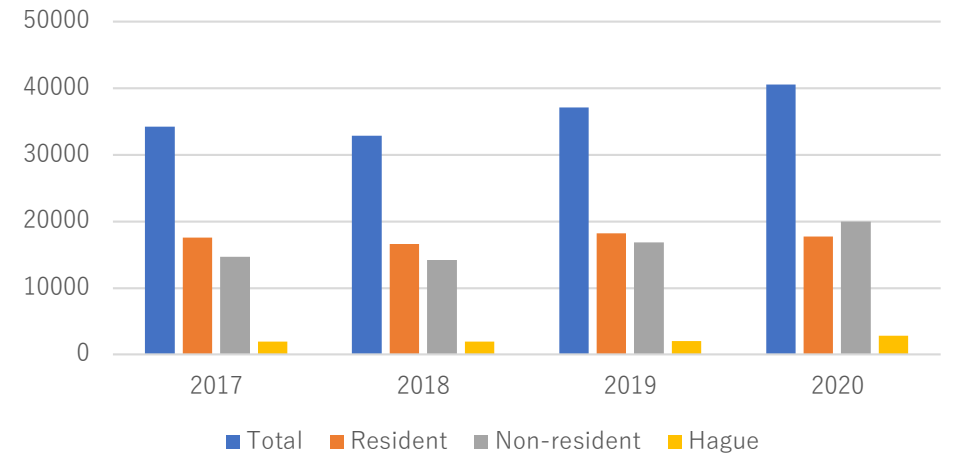
ID registrations in Japan



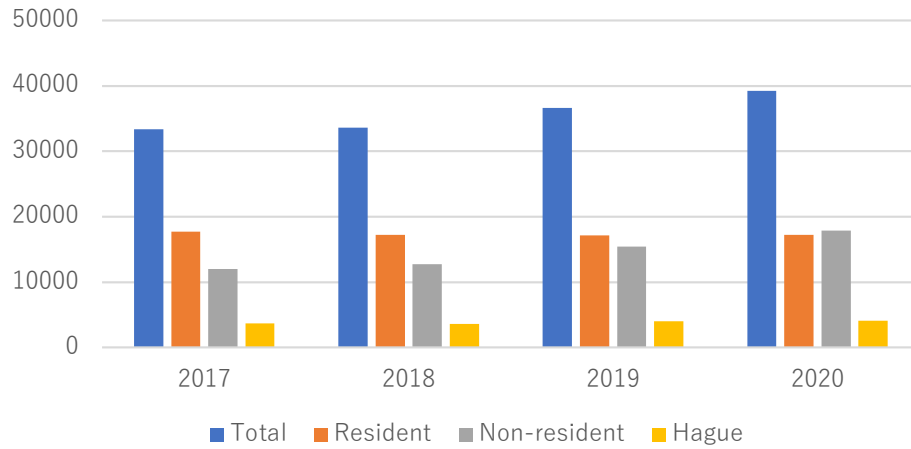
ID applications in the US



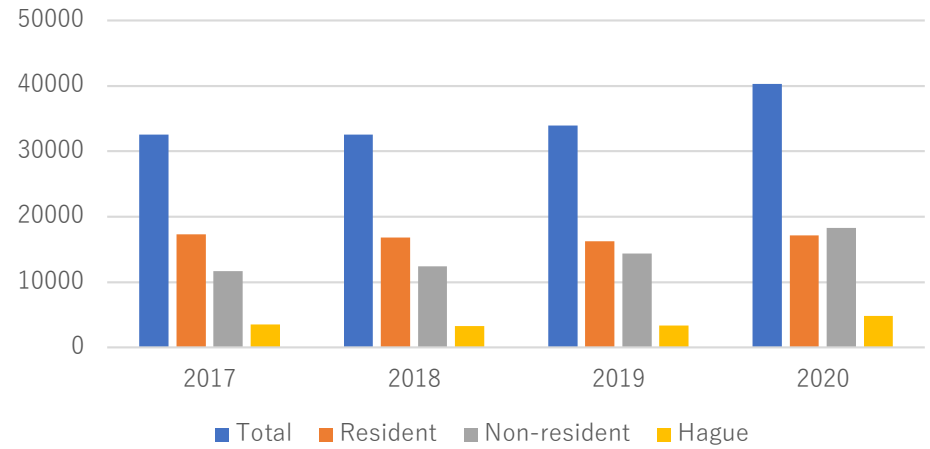
ID registrations in the US



ID applications in EUIPO



ID registrations in EUIPO



# Importance of trademark

Trademarks are identification marks used by business operators to distinguish their own goods and services from those of others.

When we purchase products or use services, we choose the trademark of a company or the name of a product or service as a mark. As business operators accumulate consumer trust in their products and services through their sales efforts, the brand image of trust and security is attached to the trademark.

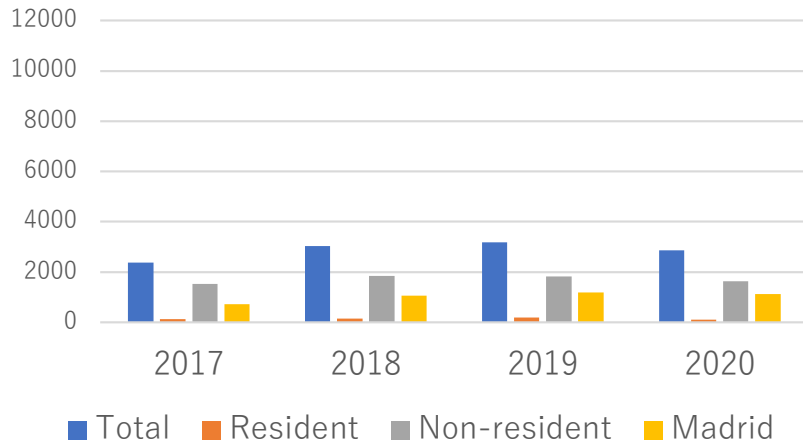


(Note) The trademarks displayed on this page are registered by their respective companies.

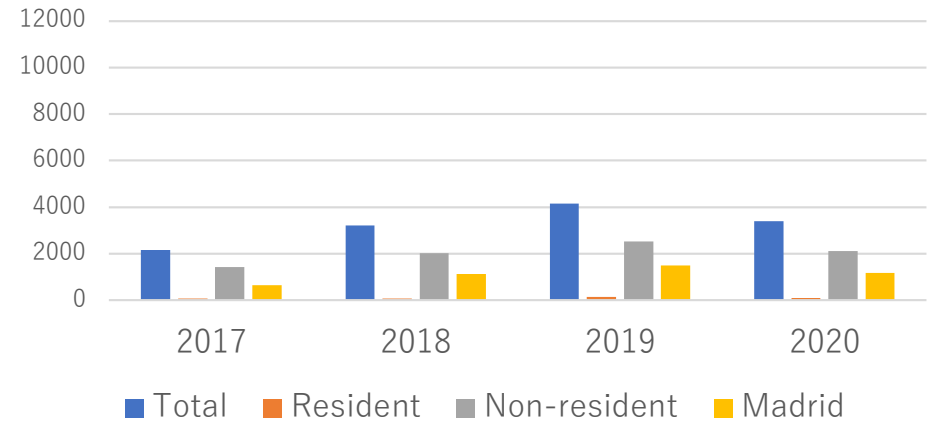
# Trademark Applications & Registrations

Source; WIPO Statistics

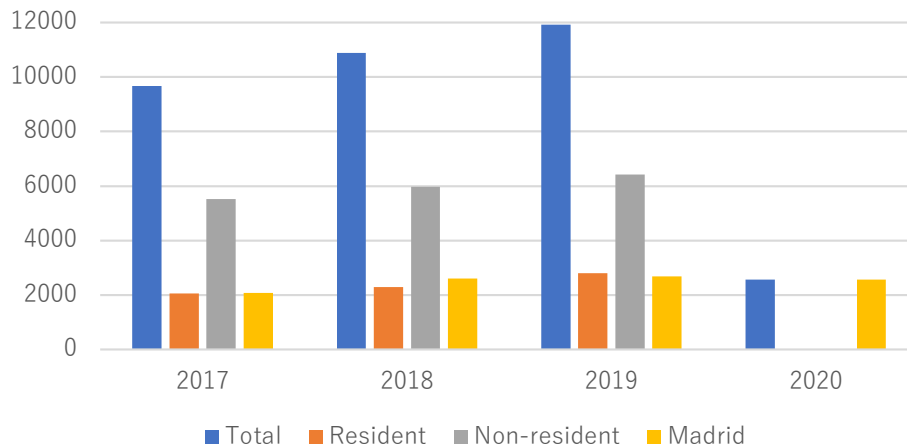
## TM applications in Brunei



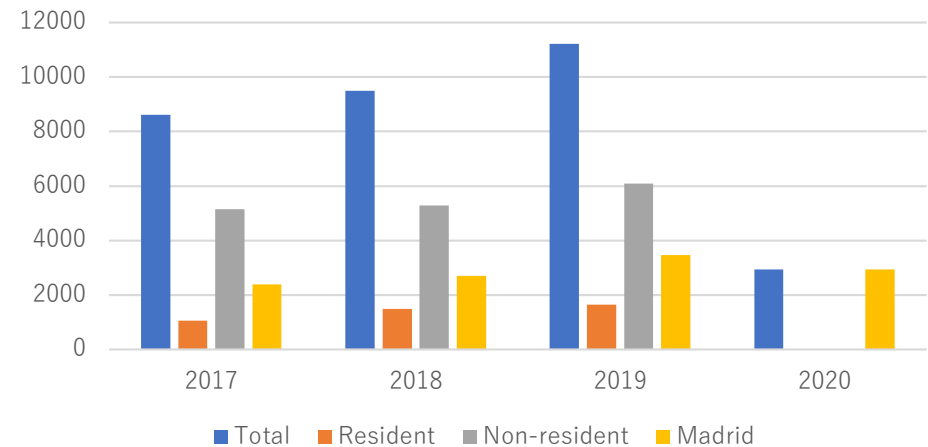
## TM registrations in Brunei



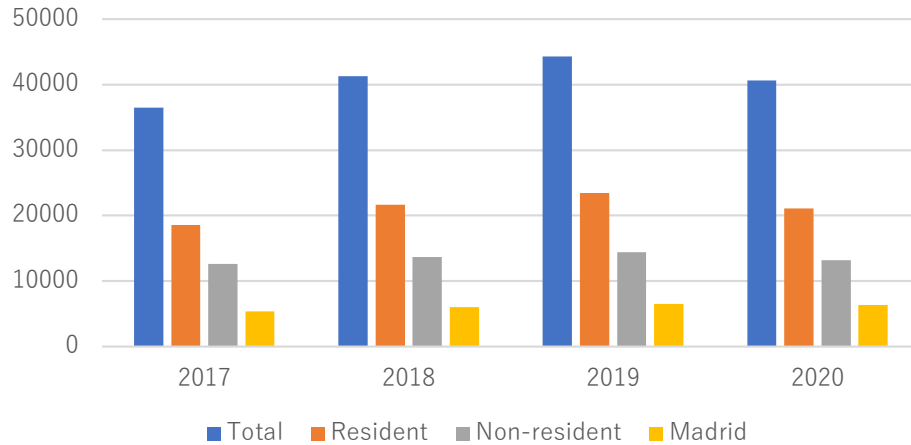
## TM applications in Cambodia



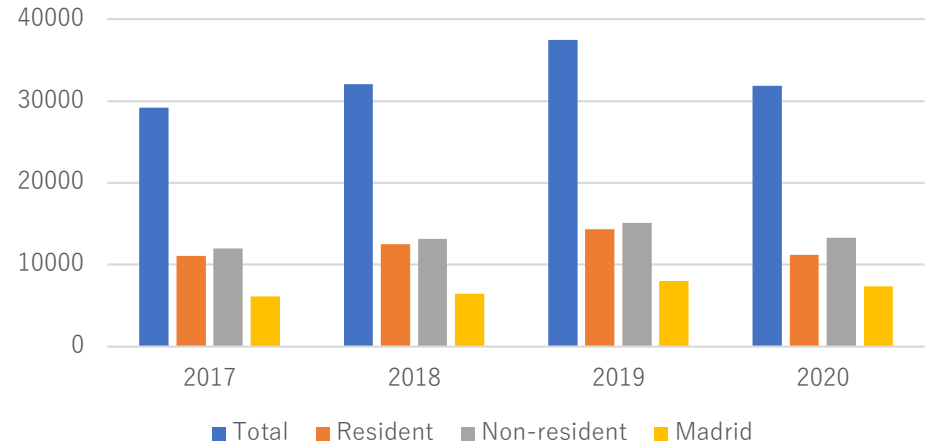
## TM registrations in Cambodia



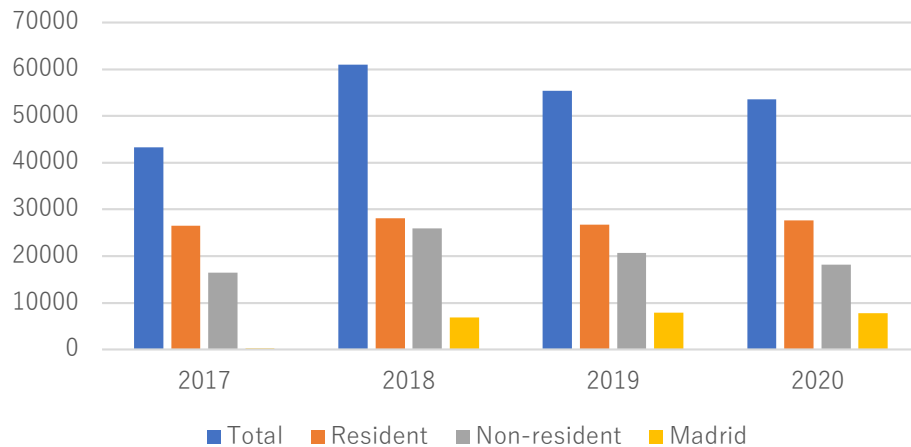
TM applications in Philippines



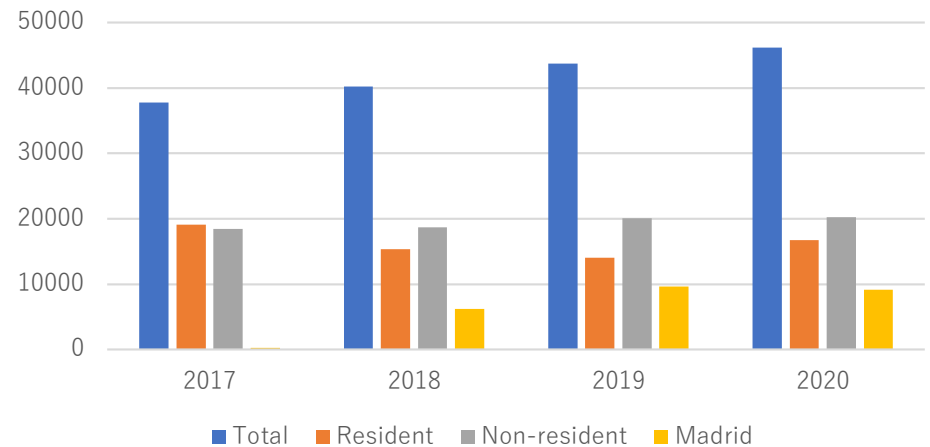
TM registrations in Philippines



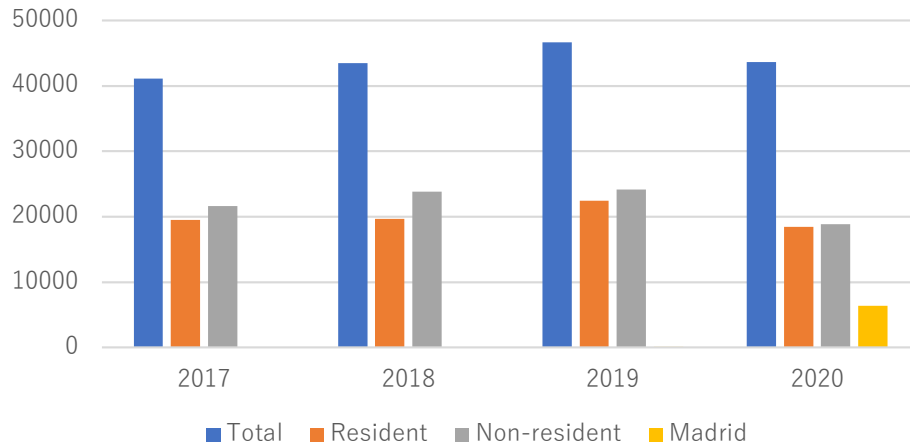
TM applications in Thailand



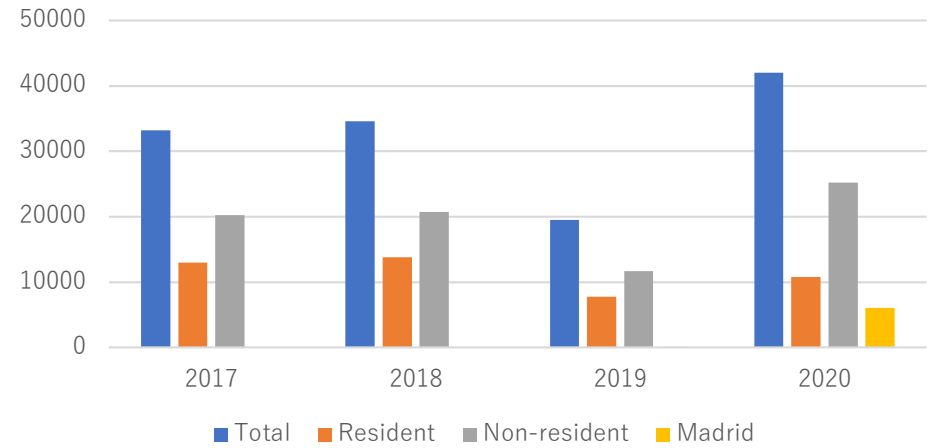
TM registrations in Thailand



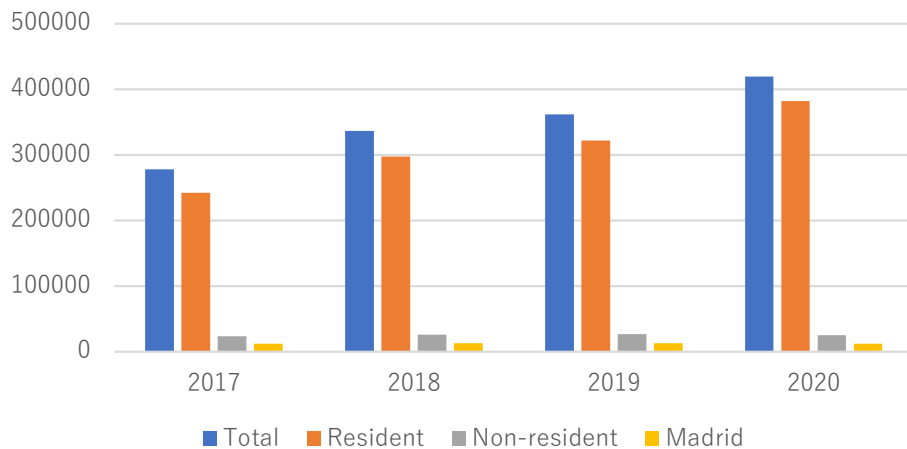
TM applications in Malaysia



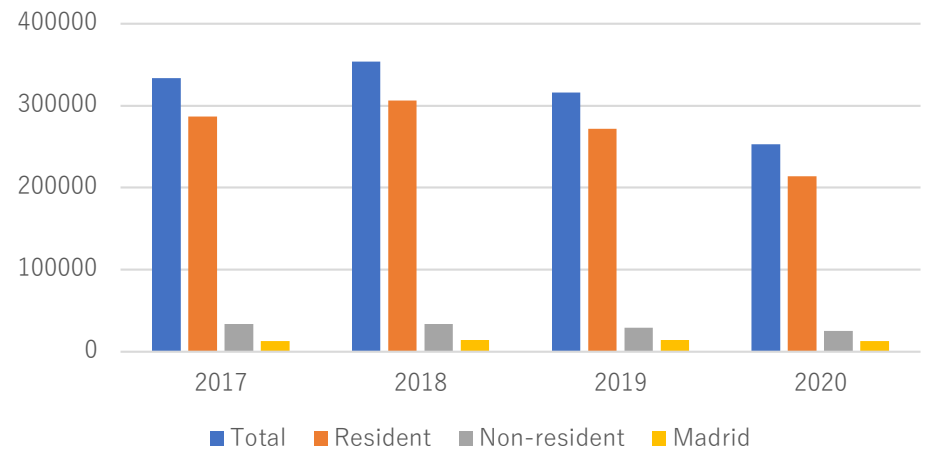
TM registrations in Malaysia



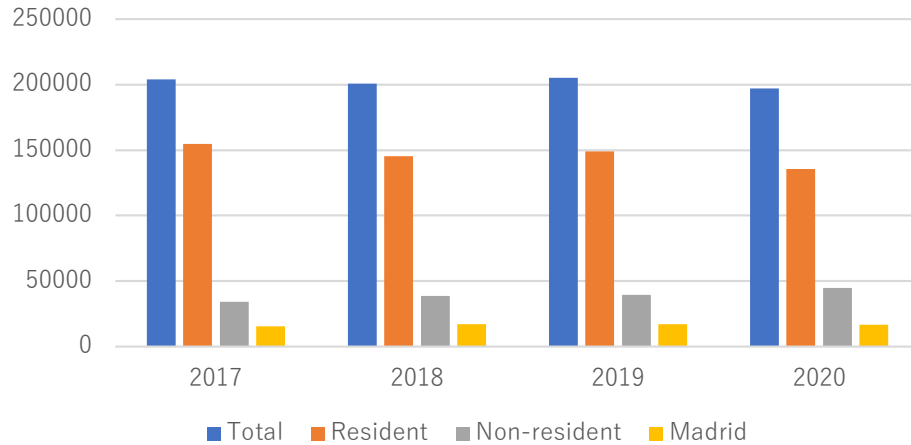
TM applications in India



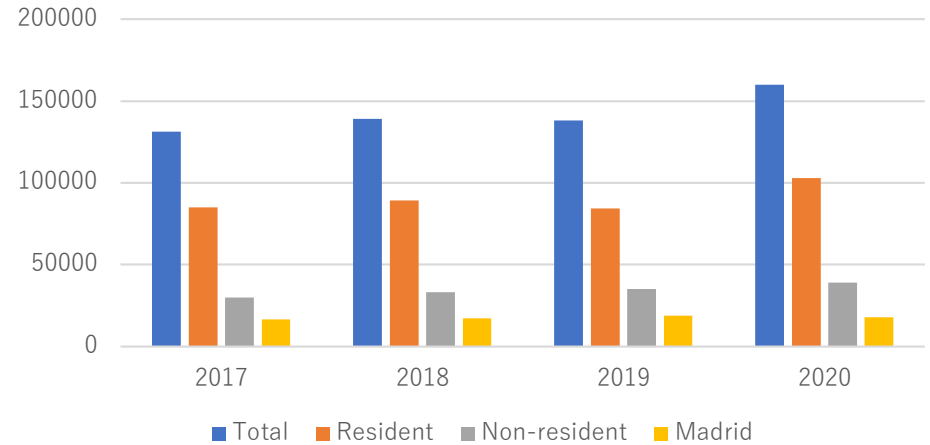
TM registrations in India



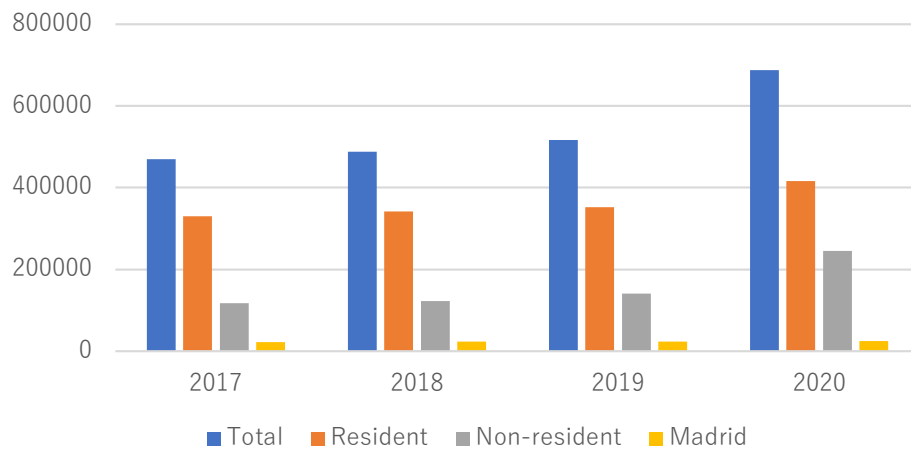
TM applications in Japan



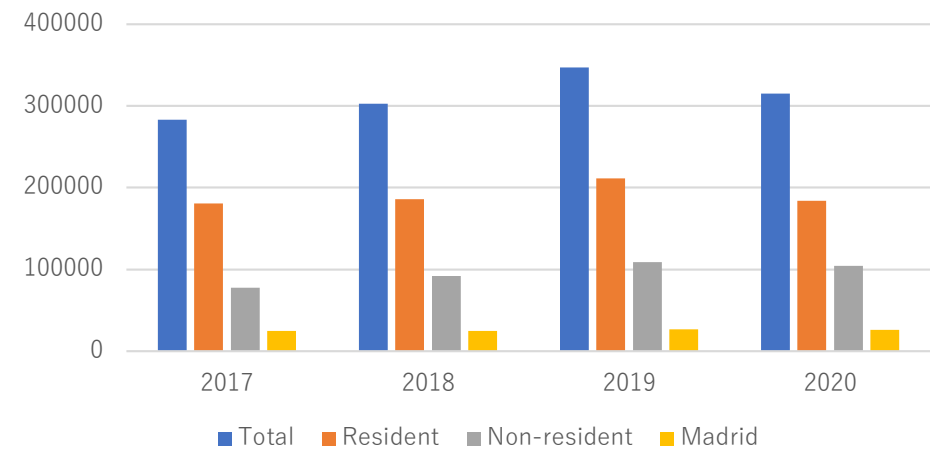
TM registrations in Japan



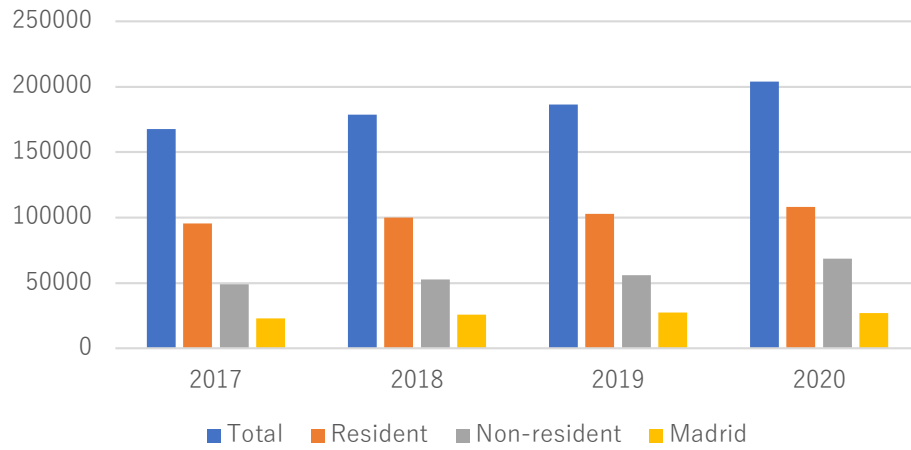
TM applications in the US



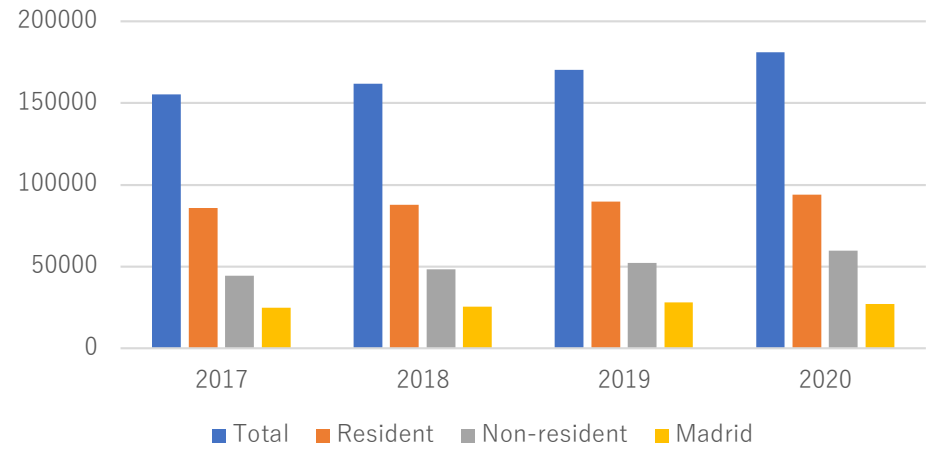
TM registrations in the US



TM applications in EUIPO



TM registrations in EUIPO





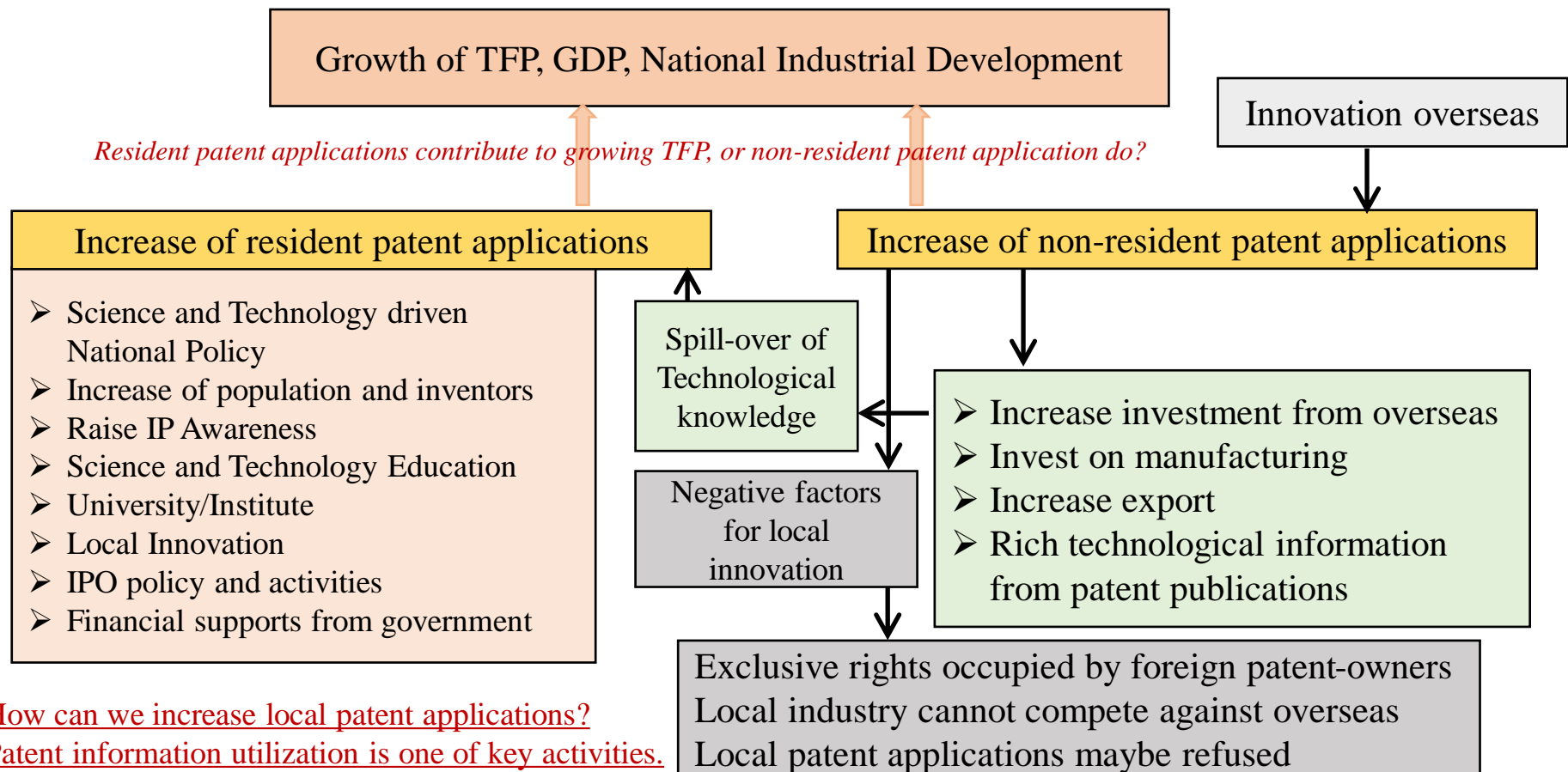
# How can we increase the number of patent applications?

## Why patent information utilization is important?

Deductive thinking on the effect of resident/non-resident applications for the growth of economy; TFP, GDP

GDP: Gross Domestic Product  
TFP: Total Factor Productivity

Increase rate of total production = Increase rate of labor input + Increase rate of capital input + Increase rate of other factors(TFP)



# Volume of total number of patent applications vs. Ratio of resident patent applications

		Ratio% of resident patent applications		
		R>70%	70%>R>30%	30%>R
Size of total number of patent applications	N>100,000	China, Japan, South Korea,	USA, EPO	
	100,000>N>10,000	Germany, France, Italy	Russia, England	India, Canada, Australia, Brazil, Mexico
	10,000>N	European countries	Ukraine, Luxembourg, Kazakhstan,	ASEAN countries

*Which arrow shall be focused first?*

Patent Examiners use patent publications to evaluate patentability.

First, the examiner defines the invention by using technical elements, normally written in its patent claims, as technical combinations [A, B, C, D, E], etc.

Then, make patent search to find prior arts to evaluate Novelty and Inventive Step.

### *How Universities, Companies should use patent publications?*

They have their missions to create inventions, innovation through their research and development activities. They have to make inventions based on their R&D.

### **What is an invention?**

An invention is a product or a process that provides, in general, a new way of doing something, or offers a new technical solution to a problem. (WIPO)

**Absolute proposition "Nothing comes from nothing"**

**Invention is a new combination of existing technical elements.**

They should learn the existing technical elements from patent publications through patent database. And, create inventions!

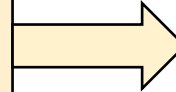
# Importance of patent information retrieval and utilization

- ✓ The invention is a new combination of existing technical elements.
- ✓ Patent information is the most effective way to obtain information on existing technical elements.
- ✓ There are far more patent applications from abroad than patent applications by applicants in our country.
- ✓ Patent applications from overseas are filed for technologies born overseas.
- ✓ Overseas technologies will be protected and foreign investment will increase.
- ✓ Exclusive rights are occupied by overseas companies.
- ✓ With the application from overseas, the technical spillover occurs.
- ✓ Based on many technological elements from abroad, our invention in our country is promoted.
- ✓ Inventions born in our country (new combinations of existing technical elements) are protected by our own patent applications.
- ✓ The technology used for innovation in our country is protected by our patent rights.
- ✓ Utilization of patent information and acquisition of patent rights will accelerate startups in our country.

# Benefits obtained by utilizing patent information

(Utilization by *macro/micro analysis*)

- Acquiring of rich technical information
- Understanding the current technical level
- Technology transition from the past
- Trends in technological innovation
- Trends in alternative technologies
- Activation of invention activities
- Innovation status and evaluation



(Viewpoint of activities by *government*)

- Analyze big data
- Promising technology forecast
- Industrial policy planning
- R & D policy planning
- Improving the capacity of policy groups
- Consulting tools for industry

(Improvement of quality by *industry*)

- Trends in patents of our company and other companies
- Corporate technology development/Business growth
- Increase the number of patent applications
- Technology licensing in/out
- Access to the required technology
- Selection of business partners
- Human resource development involved in research and development
- Raise awareness of intellectual property
- Extraction of market needs
- Trends in industry-academia collaboration

(Improvement by *academy*)

- Trends in research themes of universities and research institutes
- From basic research to commercial research
- Practical study for students
- Broaden student's eyes for industry
- Increase the number of patent applications by universities
- Research theme setting
- Bridging between university and industry

# What we should do?

1. We have to utilize patent information.
2. We have to create our own inventions by utilizing patent information.
3. We need more efficient patent information DB.
4. We have to educate/ train the people as they can easily utilize patent information.
5. We hold the workshop and invention business contest by using patent information DB.
6. Our target is to motivate people to utilize patent information.

## 2 Basic Concepts of Patent Information Searching

We **know** the specific number of publication

### I. Specific Publication No. Searching

(1) In case National IPO (or foreign IPO) sends office actions to the applicant, which patent examiner tells the prior arts with specific publication No., in connection with the reason of refusal.

If the patent publications are local publications, we have to check National IPO DB, and request to have all document to National IPO.

If the patents are foreign, we have to check the all related data and document by using WIPO PatentScope, or other global DB.

(2) In case of receiving warning letter from competitors for patent infringement, together with the specific patent No. We have to check the registration of the patents.

We **don't know** the specific number of publication

### II. Specific Technology Searching

## II. Specific Technology Searching

(1) In case of filing patent application to National IPO (or to foreign IPO), we have to evaluate the patentability on our invention in advance, by making technology searching.

(2) To make technology searching, first we have to define our invention clearly by using technical elements, as a technical combination [A, B, C, D, E].

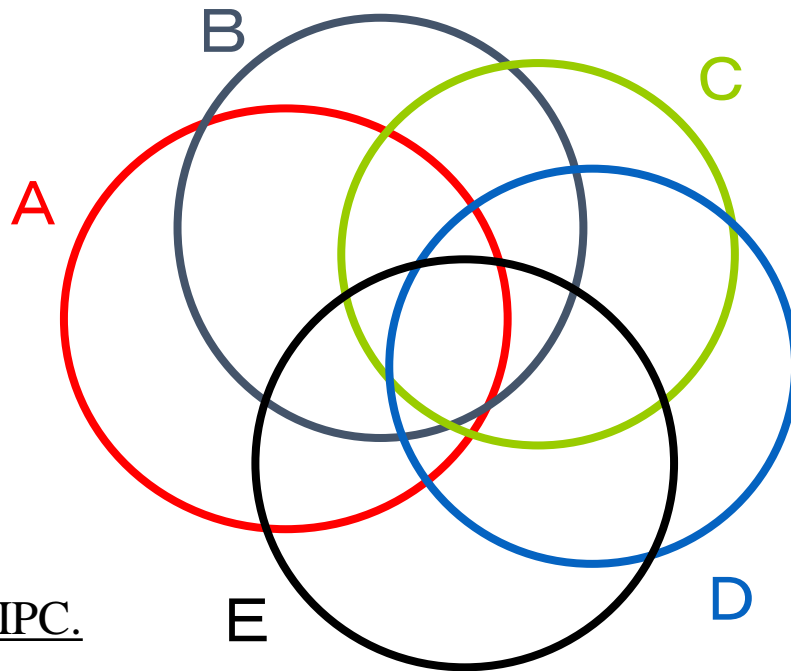
**“What is the subject of invention for searching?”**

We make specific technology searching using technical key word; simple/multiple key words, IPC.

If we find [A, B, C, D, E], lack of novelty.

If we find some combination like [A, B, C]+[C, D, E], lack of inventive step.

→Variation for searching; [A, B, C, D]+[D, E], [A, B]+[B, C, D, E], etc.

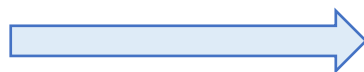




(3) **In case of R&D activities**, we need to make specific technology searching in order to make our R&D activities more efficient. We can extract technical features from this search results, by technical fields, by companies, historical trend, future perspectives, analysis between technology and marketing, etc.

**Expectation & Benefits**: We can expect to have information on the followings, by making patent publication searching.

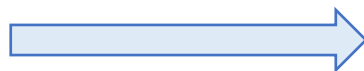
✓ Technology background



**Technology scouting**/utilization, technological improvement

✓ Technology history

✓ Technology roadmap



**R&D strategy**

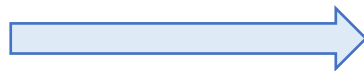
✓ Discrimination against competitors' technology

✓ Future development by technical improvement

Define business domain, business competency

✓ Innovation

✓ Technology valuation



New business/industry, **start-up**

Realize open-innovation

✓ Licensing strategy

**Business strategy**, Business growth

**Invention is a new combination of existing technical elements.**

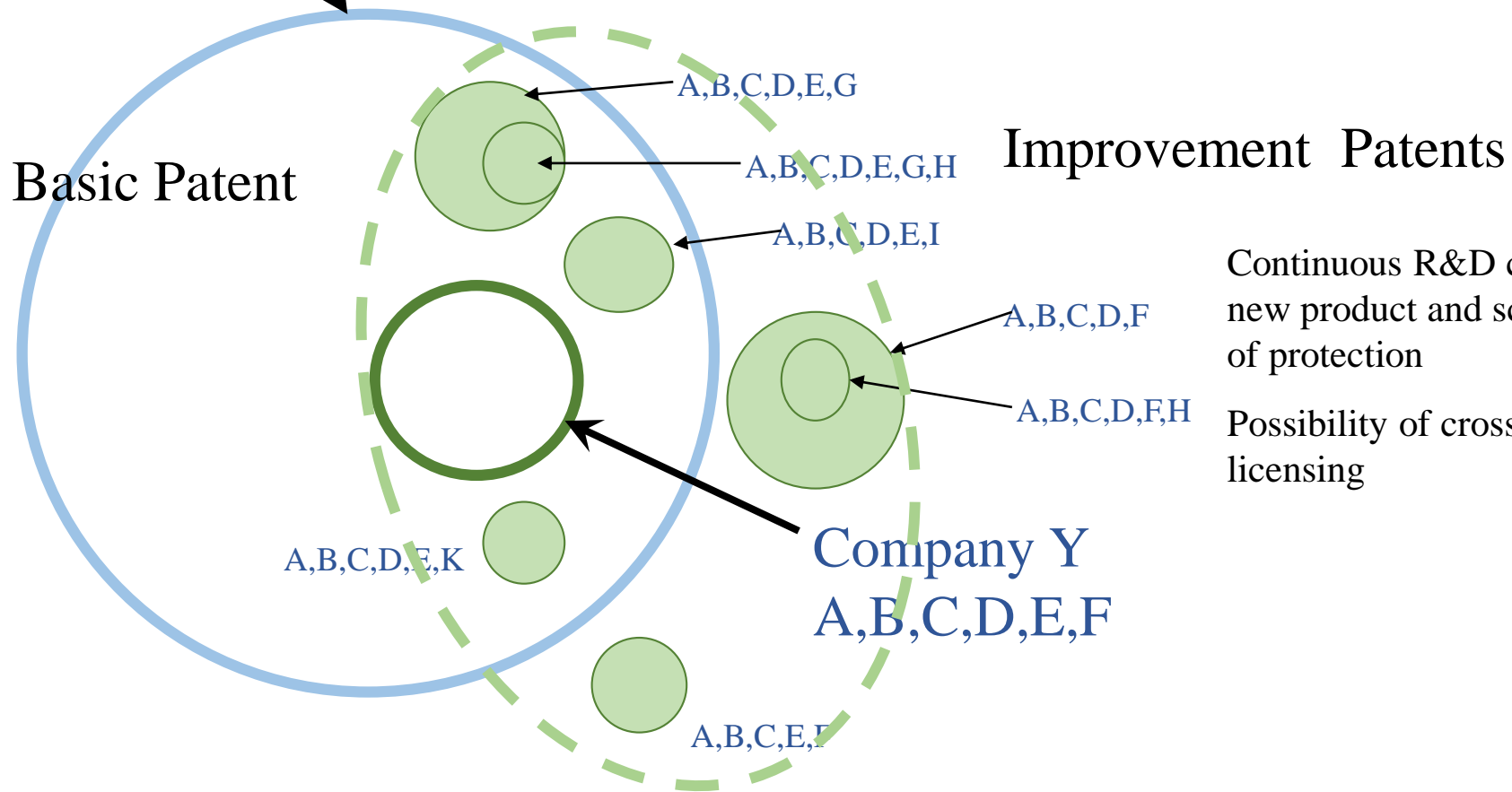
**We can obtain so many technical information through patent information searching.**

Company X

Company Y needs licensing from Company X to use the patent No.1

A,B,C,D,E

Company X needs licensing from Company Y to use the patent No.2



# Overview of Patent Search Workshop and Patent Search Contest

Countries; All ASEAN countries

Participants; Students, Researchers, Practitioners, Companies, IPO officials

Subjects for the workshop;

- “Importance of patent information for industrial development”
- “How to use local IP DB, PatentScope, and other global DB?”
- “Practical demonstration and exercises of patent information searching”

Patent Search Contest;

- Practical understandings on patent information searching through practical experiences
- Motivation up for patent information Searching through contest

Organization for workshop and contest;

- Working team is responsible for preparing workshop and contest
- Coordination and facilitation of workshop and competition

\*Necessary to have help from local expert

What is the driving factors to spread and motivate the education for patent information searching?

We expect to extract the driving factors through workshop and competition.

# Practical Flow of Contest

1. At the contest, WG provides some **subjects of inventions** (case1-7)for patent information searching
2. **Choose one subject** of invention for searching by participant
3. Understandings on the subject of invention by participants
4. Or, create a virtual invention to be searched, or define the technology to be searched by participants (researchers of university/institute/company)
5. **Define key words** to be used for searching from the subject of invention by participants
6. Carry out **searching process** to get search results by participants
7. Make **reports** in the form and make brief presentation by participants. Report form will be provided by WG.
8. **Evaluate** the submitted reports and search activities by National IPO and ERIA, and **awarding** to contest winners by National IPO.

# Example of the inventions to be searched provided by ERIA WG

1. “Glass coating having super repellent performance to the windshield of an automobile”
2. “Removable razor cartridge having magnetic elements”
3. “Method for producing microwave-resistant sheet for heat-insulating foamed paper container”
4. “Writing Instrument”
5. “Beverage ingredient capsule with a structure to reduce the risk of residual liquids and/or solids leaving the capsule after the completion of the beverage production process”
6. “Methods and compositions for affecting the flavor and aroma profiles of consumables”
7. “Automatic Lacing System”

# Participants' responsibilities

- ✓ Learn the importance on patent information searching, from the workshop.
- ✓ Choose or define one subject of invention for searching contest. (Examples of subjects of inventions will be distributed.)
- ✓ Carry out key word searching by using Espacenet.
- ✓ Fill out the reporting form and submit it in the end of Contest. (\*Reporting Form will be distributed.)
- ✓ **Brief presentation** on the search results with reflections of workshop and contest.
- ✓ Answers on the questionnaires sheet provided and submit in the end. (\*Questionnaire will be distributed.)

# Summary

1. We have to increase the number of **resident** patent applications to protect our own technologies.
2. How we can create new inventions?
3. Invention is **a new combination of the existing technical elements**.
4. How we can get the information of the existing technologies?
5. We should utilize patent information database.
6. We should be trained for **patent information searching**.
7. We can make analysis on the technical subjects to be solved, to create new combination.
8. We can try to file resident patent applications on the new invention.



# **Basic Understanding of a Patent and Patent Search**

**7 June 2023**

**Bandar Seri Begawan**

## **Takashi Koyama**

Attorney-at-law (Japan/New York), Patent Attorney

Oh-Ebashi LPC & Partners

Former Director of the Intellectual Property Affairs Division,  
Ministry of Foreign Affairs, Japan



# Table of Contents

- I. What is a Patent System and Patent Right?
- II. Patent and Trade Secret
- III. Requirements for Patent Protection
- IV. Publication of Patent Applications and Patents
- V. Patent Information Search
- VI. Patent Information Search Database

# Patent System and Patent Right

## ▶ Patent system

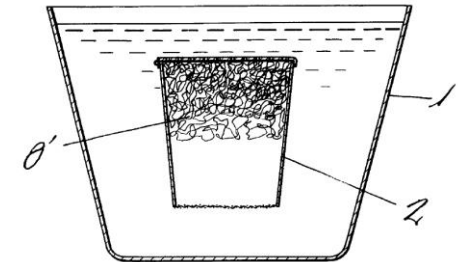
- To grant an **exclusive right** for an invention for a certain period **in exchange for the disclosure** of the said invention
- First introduced in Venice in the 13th century and then in England in the 17th century

## ▶ Patent right

- The exclusive right to **use** or **authorize** any other party to use an invention and **prohibit** any other party without his/her consent from using such invention.
  - Patent: **20 years** from the filing date

# Patent and Trade Secret

- ▶ **Patent:** exclusive right, term is limited, intended to be disclosed and publicly known
  - A process for the production of seasoning materials containing **glutamic acid** or a derivative thereof as the main constituent (JP14,805)
  - Method of manufacturing snack noodles with a container (JP924,284)
- ▶ **Trade secret:** no specific term, intended to be a secret, must be managed in confidence
  - Coca-Cola
  - Krispy Kreme Doughnuts
  - Kentucky Fried Chicken



## Famous Inventions

- ▶ Improvement in Telegraphy invented by Alexander Graham Bell (US174,465)
- ▶ Electric Lamp invented by Thomas Edison (US223,898)
- ▶ Flying-machine invented by Orville Wright & Wilbur Wright (US821,393)
- ▶ Electrophotography invented by Chester F. Carlson (US2,297,691)
- ▶ Microcomputer for Use with Video Display (personal computer) invented by Steve Wozniak (US4,136,359)
- ▶ Blue LED invented by Shuji Nakamura (US5,290,393)

# Requirements for Patent Protection

- ▶ An invention is patentable if it is **new**, involves an **inventive step** and is **industrially applicable**.
  
- ▶ An invention that encourages offensives, immoral or anti-social behavior is **not patentable**, even if it satisfies the requirements of patentability.

## Requirements for Patent Protection (cont.)

- ▶ **Novelty**: An invention is **new** if the invention has not yet been publicly disclosed **in any form, in anywhere in the world.**
  - ▶ **Grace Period** (one year) is available.
  
- ▶ **Inventive step**: An invention involves an inventive step that if, having regard to prior art relevant to the application claiming the inventions, it is **not obvious for someone with technical skills or knowledge in that particular field.**

## Requirements for Patent Protection (cont.)

- ▶ **Industrial applicability**: An invention is capable of industrial applicability, if it **can be made or used in any kind of industry**, including agriculture.
  - An invention of a method of treatment on the human or on an animal body involving surgery, therapy or diagnosis is **NOT** patentable as they cannot be applied industrially.

## Publication of Patent Applications and Patents

- ▶ A patent application will be published by BruIPO as soon as possible **after the expiration of 18 months** from the priority date or the date of filing the application.
- ▶ An international application under the **PCT** (Patent Cooperation Treaty) will be internationally published by the International Bureau (WIPO) **after 18 months from the priority date**.
- ▶ BruIPO records and publishes a patent that has been granted.
- ▶ The publication of patent applications and patents are useful source to determine novelty and inventive step requirements.



# Patent Information Search

- ▶ **Why** and **when** do you need to do a patent information search?
  - When you have invented something: You may want to know if your invention can be patented (novelty and inventing step requirements).
  - When you are considering a new business/product: You need to check if your potential new business/product does not infringe others' (future) patents.
  - When you invest or start an R&D activity: You need to know in which area you can successfully invest or what type of business/product can be successfully marketed.
  - When you learn about a competitors' patent application or patent: You may want to remove potential obstacles to your current or future business/product by opposing or invalidating such patent application or patent.

## Patent Information Search (cont.)

- ▶ **Why** and **when** do you need to do a patent information search?
  - When you obtain a license from a patentee: You need to assess the validity and value of the subject patent.
  - When you market a new product: You need to make sure that your new product does not infringe others' (future) patents.
  - When you are warned by a patentee: You need to analyze and assess whether your business/product infringes a patent and whether the patent could be invalidated.
  - When you look for technology trends: You may understand the current and future technology trends in a specific industry.

**Patent information is a useful source to consider/decide the above!**

# Patent Information Search Database

- ▶ BrulPO Patent Search Database
- ▶ WIPO PATENTSCOPE
- ▶ ASEAN PATENTSCOPE
- ▶ USPTO, JPO (INPIT), EPO's databases
  - PatFT, AppFT, PAIR...
  - J-PlatPad
  - Espacenet
- ▶ Google Patents
- ▶ Commercial IP databases, such as PatSnap

# BruIPO Patent Search Database



Basic

Enter Keyword(s)

Search

Showing 1 - 50 of 599 results

Registration Date



**Title:** **THREADED CONNECTION**

**Original Filing Number:** N/2021/0112

**Priority Details:** JP JP2019-172936

**Registration Number:** BNN20210112

**Applicant:** NIPPON STEEL CORPORATION VALLOUREC OIL AND GAS FRANCE

**Filing Date :** 20.08.2020

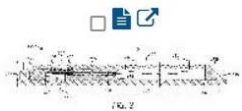
**IPC Classes:**

**Registration Date:** 23.05.2022

**Inventor:** MARUTA, Satoshi OKU, Yousuke FOTHERGILL, Alan SUGINO, Masaaki

**Abstract:** The purpose of the present invention is to improve the productivity of a screw-threaded joint having a two-stage screw structure including an intermediate shoulder surface by facilitating machining of the intermediate shoulder surface and by preventing cracking near an intermediate critical cross-section under tensile load. On the outer circumference of a pin 2 between an intermediate shoulder surface 24 and a second male screw 27 of the pin 2, a circumferential direction groove 25 having a curved surface 25a smoothly continuous with the intermediate shoulder surface 24 is provided, and thus plastic strain that occurs near a pin intermediate critical cross-section PICCS is reduced. Further, on the inner circumference of a box 3 between an intermediate shoulder surface 35 and a first female screw 32 of the box 3, a circumferential direction groove 34 having a curved surface 34a smoothly continuous with the intermediate shoulder surface 35 is provided, and thus plastic strain that occurs near a box intermediate critical cross-section BICCS is reduced.

**Status:** Registered



**Title:** **FLOW CONTROL DEVICES WITH PRESSURE-BALANCED PISTONS**

**Original Filing Number:** N/2019/0060

**Priority Details:**

**Registration Number:** BNN20190060

**Applicant:** HALLIBURTON ENERGY SERVICES, INC.

**Filing Date :** 27.12.2016

**IPC Classes:** E21B 43/02, E21B 43/08, E21B 43/12

**Registration Date:** 21.05.2022

**Inventor:** FRIPP, Michael Linley FROSELL, Thomas Jules GANO, John C. ORNELAZ, Richard Decena

**Abstract:** A sand control screen assembly includes a base pipe and a flow control device positioned within a flow path for a fluid that extends between the exterior and the interior of the base pipe. The flow control device includes a housing defining an inlet that receives the fluid from the flow path and an outlet that discharges the fluid back into the flow path, and a piston chamber is defined in the housing to fluidly communicate the inlet with the outlet. A pressure-balanced piston is positioned within the piston chamber and movable between a first position, where fluid flow between the inlet and the outlet is prevented, and a second position, where fluid flow between the inlet and the outlet is facilitated. An actuator moves the pressure-balanced piston between the closed and open positions, and an electronics module is communicably coupled to the flow control device to operate the actuator.

--

**Status:** Registered

# WIPO PATENTSCOPE

The screenshot shows the WIPO PATENTSCOPE search interface. At the top, there is a navigation bar with 'WIPO IP PORTAL', 'MENU', 'PATENTSCOPE', 'HELP', 'ENGLISH', 'LOGIN', and 'WIPO'. Below this, there are links for 'Feedback', 'Search', 'Browse', 'Tools', and 'Settings'. The main heading is 'SIMPLE SEARCH'. A text block provides information about the search capabilities, mentioning 106 million patent documents and 4.4 million PCT applications. Below this is a search form with a 'Field' dropdown menu and a 'Search terms...' input field. A callout box points to the 'Field' dropdown, listing options: Front page, Any Field, Full Text, ID/Number, Int. Classification (IPC), Names, and Publication Date. Another callout box points to the 'Search' link, listing advanced search options: Simple, Advanced Search, Field Combination, Cross Lingual, Expansion, and Chemical compounds. An upward arrow is visible in the bottom right corner of the page.

WIPO IP PORTAL MENU PATENTSCOPE HELP ENGLISH LOGIN WIPO

Feedback Search Browse Tools Settings

## SIMPLE SEARCH

Using PATENTSCOPE you can search 106 million patent documents including 4.4 million published international patent applications (PCT). [Detailed information](#)

PCT publication 33/2022 (18.08.2022) is now available [here](#). The next PCT publication 34/2022 is scheduled for 25.08.2022. [More](#)

Check out the [new PATENTSCOPE features](#): CPC, NPL, Families ...

[Search Facility to Support COVID-19 Innovation Efforts](#)

Field  
Front Page Search terms...

Field  
Front page  
Any Field  
Full Text  
ID/Number  
Int. Classification (IPC)  
Names  
Publication Date

Simple  
Advanced Search  
Field Combination  
Cross Lingual  
Expansion  
Chemical compounds

↑

<https://patentscope2.wipo.int/search/en/search.jsf>

# USPTO Patent Search Databases



United States Patent and Trademark Office

An Agency of the Department of Commerce

Patent Full-Text Databases

## PatFT: Patents

*Full-Text from 1976*

[Quick Search](#)  
[Advanced Search](#)  
[Number Search](#)

[View Full-Page Images](#)

[PatFT Help Files](#)  
[PatFT Status, History](#)  
[PatFT Database Contents](#)

[Report Problems](#)

<< BOTH SYSTEMS >>

*The databases are operating normally.*

[Notices & Policies](#)

[How to View Images](#)

[Assignment Database](#)

[Public PAIR](#)

[Searching by Class](#)

[Sequence Listings](#)

[Attorneys and Agents](#)

[Privacy Policy](#)

## AppFT: Applications

*Published since March 2001*

[Quick Search](#)  
[Advanced Search](#)  
[Number Search](#)

[View Full-Page Images](#)

[AppFT Help Files](#)  
[AppFT Status, History](#)

[Report Problems](#)

# J-PlatPad

## Patent/Utility Model Search

[Help](#)

You can retrieve patent/utility model publications, foreign documents, and non-patent documents by using keywords in bibliographies, abstracts, and claims, as well as classifications (FI/F-terms, IPC), etc.

Enter a document type and a search keyword to search. (An OR search is performed when you separate search keywords with a space.)

For more information about classification information, see [Patent/Utility Model Classification Search \(PMGS\)](#).

Selective Input Logical Expression Input

Search target text

Japanese text  English text

Document types Advanced Settings +

Domestic documents (PAJ)  Foreign Documents  J-GLOBAL

Search keywords

Search item      Keyword

Title/name of invention or device      Ex) 'Semiconductor memory device'

Delete      AND

Abstract      Ex) Composition

Delete      AND

FI      Ex) C04B35/49

Delete      AND

IPC      Ex) B01B1/00

Delete  Add

Exclusion keywords Specify a keyword to exclude from the search result. Open +

Search options Open +

Options : Not specified

# Espacenet



**Espacenet**  
Patent search

Enter your search terms



Office/Language ▾

My Espacenet

Help

Classification search

Results



Advanced search

Feedback

**Espacenet: free access to over 130 million patent documents**

classification  
search

advanced  
search



## Quick access

Discussion forum

Pocket guide

<https://youtu.be/b-db0qRtoag>



# Google Patents

Google Patents



SEARCH TERMS ⓘ

+ Synonym

SEARCH FIELDS

📅 Date · Priority ▾

YYYY-MM-DD — YYYY-MM-DD

👤 + Inventor

🏢 + Assignee

Patent Office ▾ Language ▾

Status ▾ Type ▾

Litigation ▾

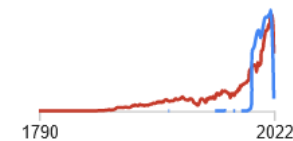
×

## Advanced search

To learn more about searching, visit [About Google Patents](#) for help.

### Patent offices

CN	JP	US	DE	EP	KR	WO	GB	FR	CA
AU	TW	ES	RU	SU	IT	AT	BR	SE	CH
PL	NL	BE	DK	TH	NO	FI	MX	IL	ZA
UA	HU	DD	PT	CS	AR	HK	SG	NZ	CZ
IE	GR	EA	TR	MY	RO	IN	LU	PH	BG
YU	SI	CL	SK	CO	HR	MA	PE	LT	RS
OA	CY	UY	EC	MD	AP	ID	EG	CR	TN
LV	IS	EE	GE	SA	GT	CU	DO	JO	SM
ME	MC	ZM	ZW	PA	HN	NI	SV	DZ	KE
MW	MT	TJ	GC	MN	VN	BA	KZ	BY	UZ
KG	AM	TT	MO	EM					



Grants **12,419,263**

Full-text since 1790

Applications **7,016,967**

Full-text since 2001

These totals include all patents and published applications in our index, but we cannot guarantee complete coverage. If we're missing anything, please let us know!

# Patent Information Search Databases

- ▶ Simple search and advanced search are normally available.
- ▶ Some databases contain full-text patent documents, while some only contain their abstracts or limited information.
- ▶ Typical search terms are the following:
  - Title of invention;
  - Field of technology;
  - Name of inventor/applicant/patentee;
  - International Patent Classification (IPC)/Cooperative Patent Classification (CPC);
  - Application number, publication number, patent number; and
  - Date of publication.
- ▶ Combination of keywords/terms/fields gives you more related results.
- ▶ Non-patent database is also a useful source.

# Thank you for your attention!

**Takashi Koyama**

Oh-Ebashi LPC & Partners

<https://www.ohebashi.com/en/>

TEL: +81-(0)3-5224-5062 (direct)

FAX: +81-(0)3-5224-5565

Email: [takashi.koyama@ohebashi.com](mailto:takashi.koyama@ohebashi.com)



# When and for what purpose should we make patent information search

**7, June, 2023**

**Yorihisa Katsunuma**

General Manager, Intellectual Property Dept.  
Ajinomoto Co., Inc.

# Table of Contents

1. Introduction
2. What you can find out through patent search
3. Introduction of the case
4. Patent search on various Stages in R&D through commercialization, and its purpose
5. Contents of patent search
6. Closing

# Table of Contents

1. Introduction
2. What you can find out through patent search
3. Introduction of the case
4. Patent search on various Stages in R&D through commercialization, and its purpose
5. Contents of patent search
6. Closing

# 1. Introduction

Patent information search gives you a variety of suggestions



Patent Search



Patent Data Base



Such as

- Technologies already made public (prior art)
- Company/Organization who owns the patent right
- Country that the patent was filed or registered
- Extent that the patent right is granted to a third party
- Expiry date of the patent right
- Trend of current and advanced invention

# 1. Introduction

- Generally, a patent discloses the useful technologies to the public, so patent information search gives you the knowledge of the technology already created by a third party.



- Therefore, patent information serves you to show the newest technology from which you may start your own work.



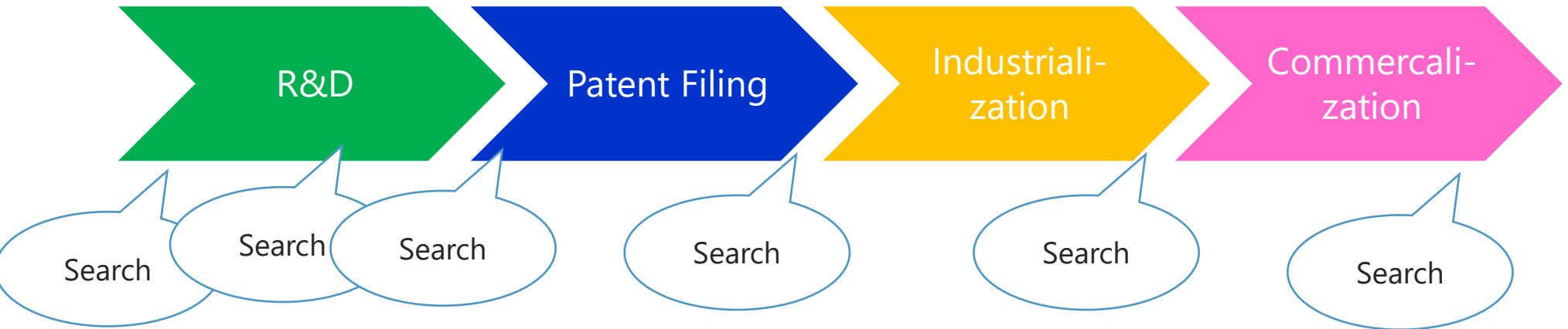
# 1. Introduction

- Imagine.
- At what time the patent search is necessary in various stages of the business, from R&D through Commercialization?



# 1. Introduction

- Patent Search is necessary in every stages of the business, from R&D through Commercialization.



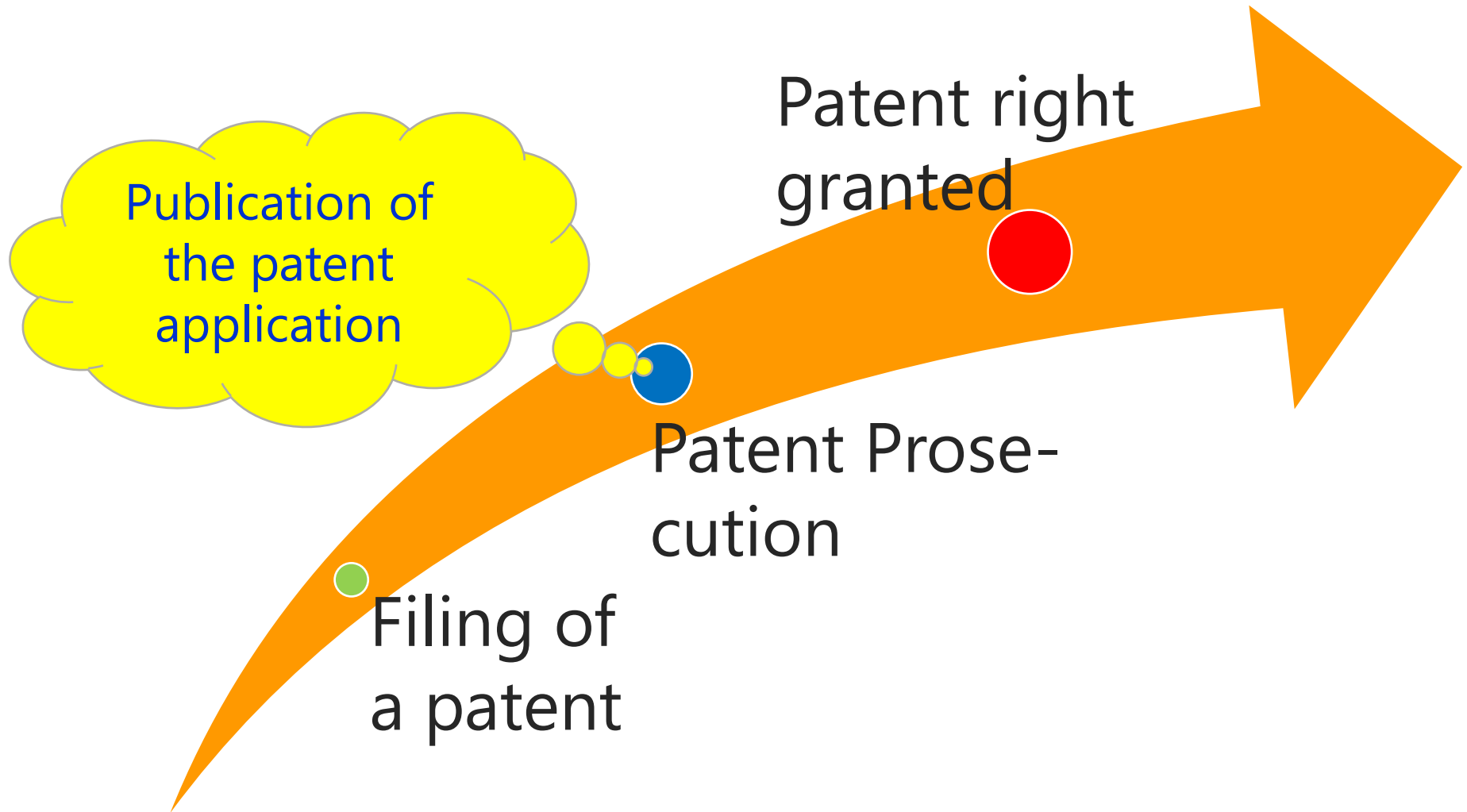
# Table of Contents

1. Introduction
2. What you can find out through patent search
3. Introduction of the case
4. Patent search on various Stages in R&D through commercialization, and its purpose
5. Contents of patent search
6. Closing

# Table of Contents

1. Introduction
2. What you can find out through patent search
3. Introduction of the case
4. Patent search on various Stages in R&D through commercialization, and its purpose
5. Contents of patent search
6. Closing

## 2. What you can find out through patent search



## 2. What you can find out through patent search

- ▶ What you can find out
  - Patents filed by a third party (i.e. prior art)
  - Extents that a third party owns patent right (including the date of expiry)
  - The name of the researcher who has developed the technology
  
- ▶ What you cannot find out
  - Contents of patent filed by a third party, which is not published yet.

# Table of Contents

1. Introduction
2. What you can find out through patent search
3. Introduction of the case
4. Patent search on various Stages in R&D through commercialization, and its purpose
5. Contents of patent search
6. Closing

# Table of Contents

1. Introduction
2. What you can find out through patent search
3. Introduction of the case
4. Patent search on various Stages in R&D through commercialization, and its purpose
5. Contents of patent search
6. Closing



### 3. Introduction of the case

- Suppose you come up with a new bottle for liquid seasoning whose package is composed of two layers, and when you use the seasoning, the inner bottle has the function to protect the freshness of contents by blocking the insertion of air.

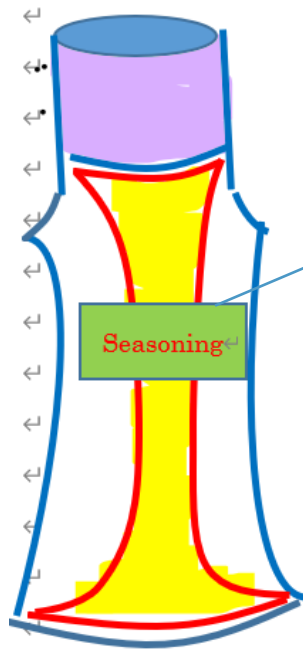


#### "Two Layer Bottle"

When you purchase the seasoning, the outer layer and inner layer is adhered closely, because the inner bottle is full of seasoning. As no air is existing in the inner bottle, the freshness of the seasoning is maintained.

### 3. Introduction of the case

- If you use the seasoning, the quantity of the contents decreases. If the bottle is the one which have been existing, air trespasses to the bottle, and the product contacts to the air. However, with this Two Layer Bottle, the inner layer has the mechanism to shrink by itself, and no air trespass to the inner bottle.



Through this mechanisms, the seasoning is maintained fresh for a longer period of time. The point of this invention is (i) the structure that the air insert to the space between outer and inner layer, and (ii) the valve which have the function to lead the air not to the inner layer but to the space between the outer and inner layer.

# Table of Contents

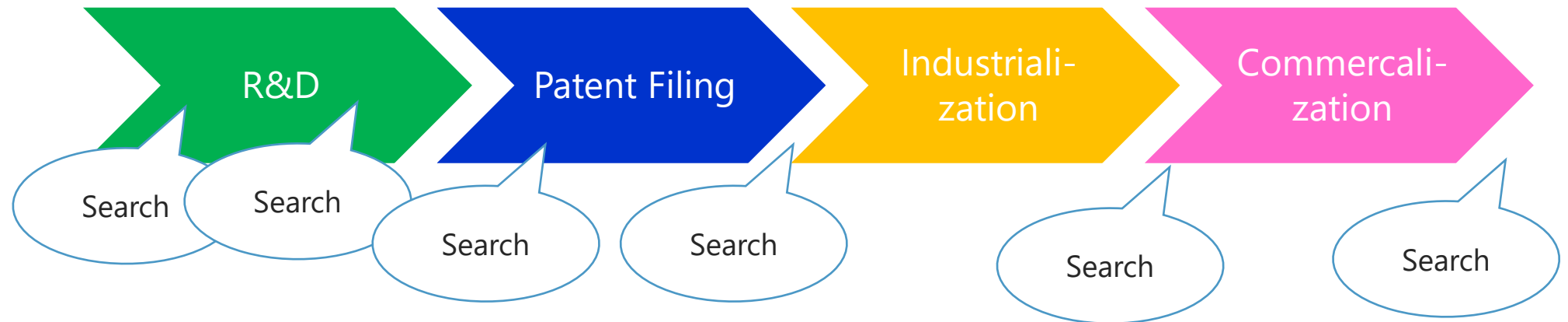
1. Introduction
2. What you can find out through patent search
3. Introduction of the case
4. Patent search on various Stages in R&D through commercialization, and its purpose
5. Contents of patent search
6. Closing

# Table of Contents

1. Introduction
2. What you can find out through patent search
3. Introduction of the case
4. Patent search on various Stages in R&D through commercialization, and its purpose
5. Contents of patent search
6. Closing

## 4. Patent search on various Stages in R&D through commercialization, and its purpose

- Patent Search is necessary in various stages of the business.



## 4. Patent search on various Stages in R&D through commercialization, and its purpose



Search



➤ Patent Search is necessary before starting R&D

## 4. Patent search on various Stages in R&D through commercialization, and its purpose



You come across a concept of invention



What would be done next?



Start R&D to verify if the concept of invention is new and may be used.

What if there is a third party's patent which is the same as your invention?



Your R&D has no meaning.



Before starting R&D, patent search is necessary.

#### 4. Patent search on various Stages in R&D through commercialization, and its purpose

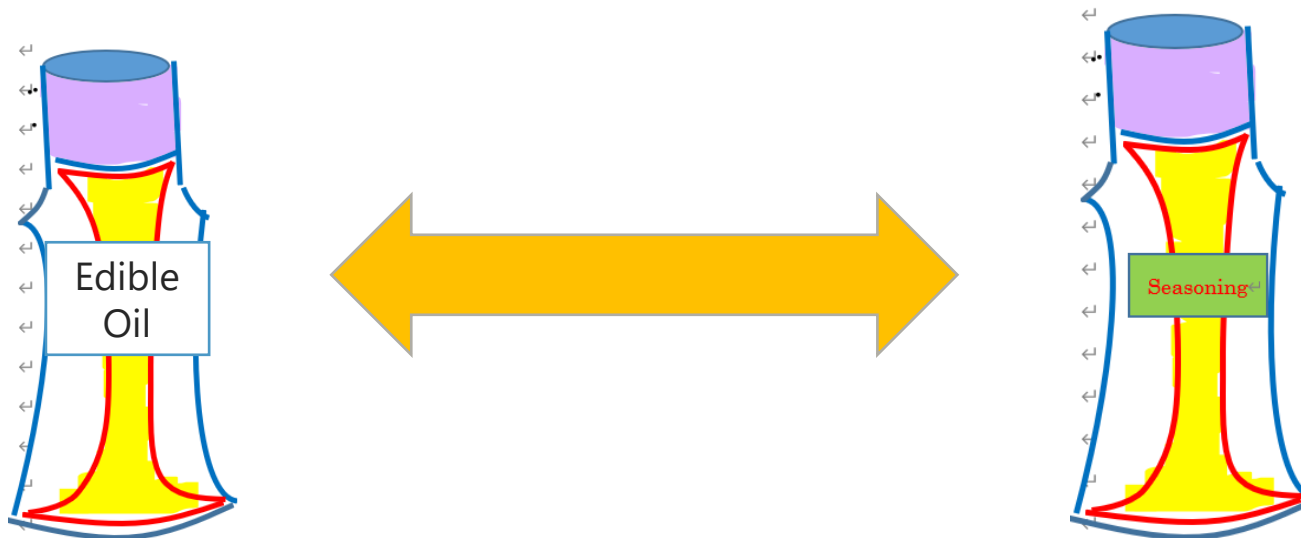
Through the patent search before starting R&D,

<b>You may find out the existence of</b>	<b>Purpose: To find out the feasibility to start you R&amp;D</b>
The same or similar patent by a third party as or to your invention	If the same or similar patent is existing, your R&D may be mere the repetition of third party's R&D
The same problem of a third party as you would like to solve	If you are a university or research organization, you may find out a potential company to use your invention



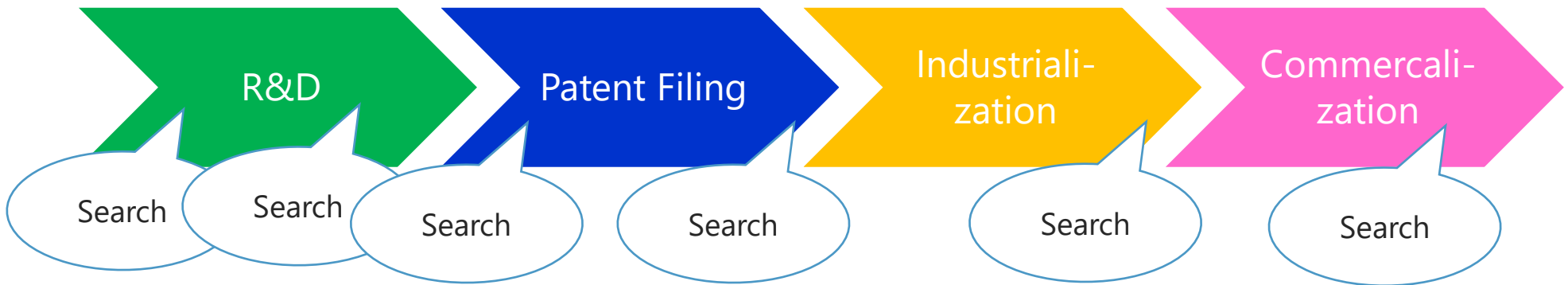
#### 4. Patent search on various Stages in R&D through commercialization, and its purpose

If you find out a similar patent for “edible oils”, you can start a study to find out whether you may obtain an advanced invention for liquid seasoning which is so different from edible oils as to be called inventive step.

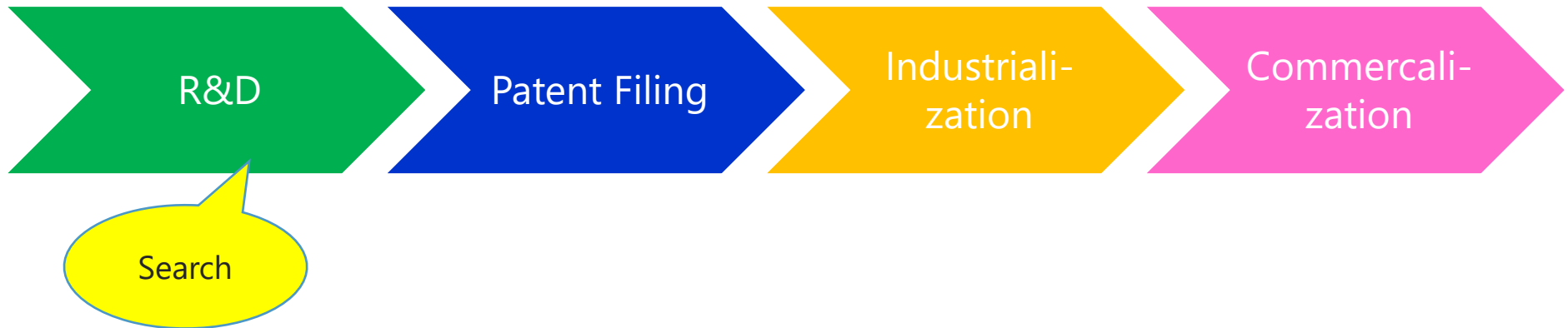


## 4. Patent search on various Stages in R&D through commercialization, and its purpose

- Patent Search is necessary in various stages of the business.

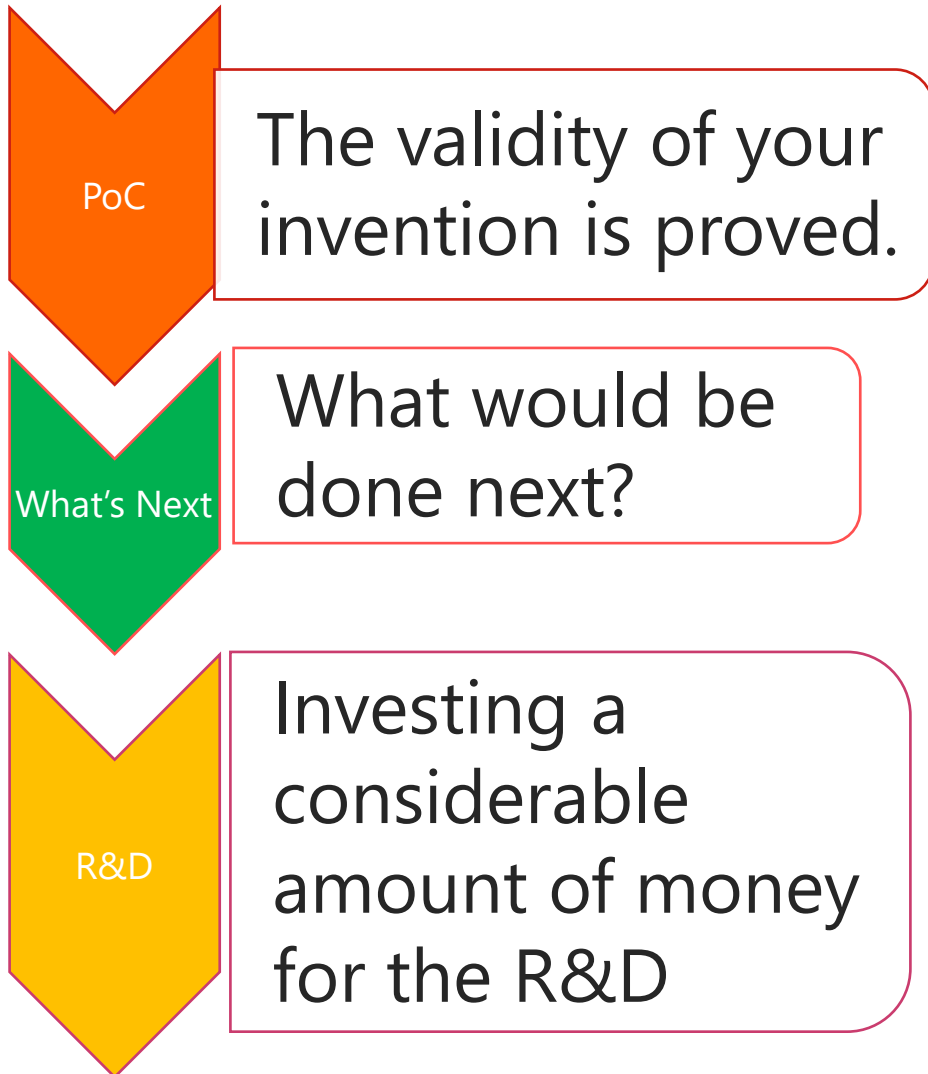


## 4. Patent search on various Stages in R&D through commercialization, and its purpose



➤ Patent Search is necessary before investing considerable amount of money for the R&D

#### 4. Patent search on various Stages in R&D through commercialization, and its purpose



What if there is a third party's patent which is an obstacle to use your invention?



Your investment may not lead to a profitable invention.



Before a big investment for R&D, patent search is necessary.

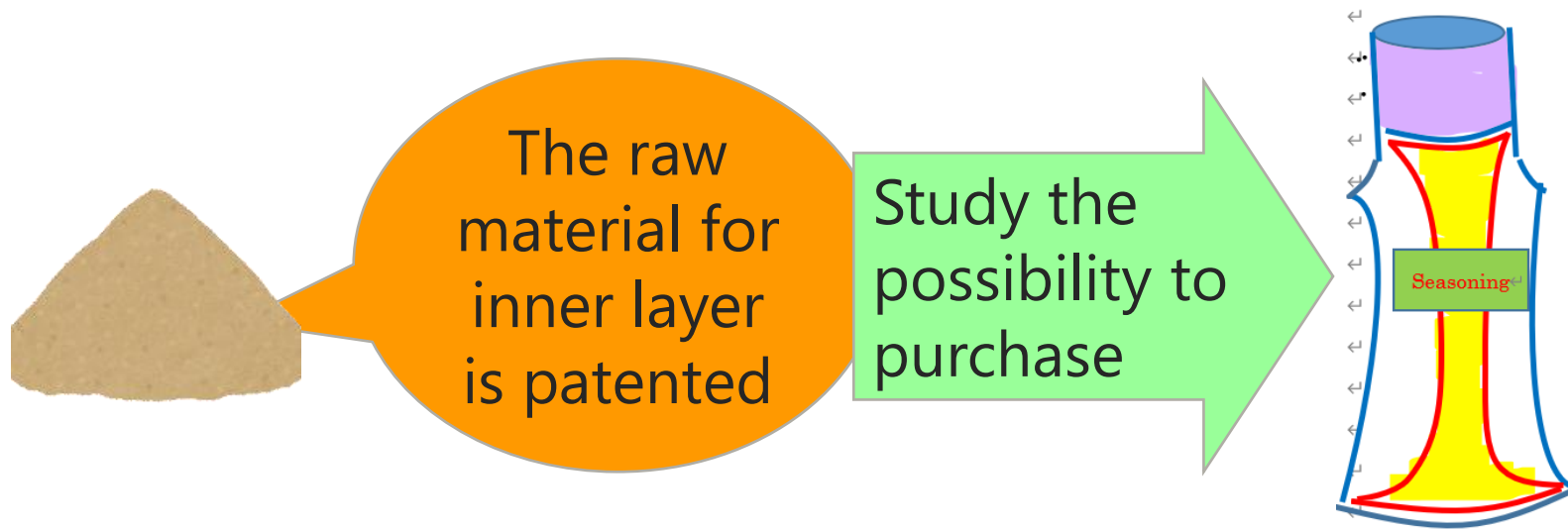
#### 4. Patent search on various Stages in R&D through commercialization, and its purpose

Through the patent search before a big investment for R&D,

<b>You may find out the existence of</b>	<b>Purpose: To find out the feasibility to invest a big money for you R&amp;D</b>
A blocking patent (i.e. a patent which prevents the use of your invention) by a third party	If a blocking patent is existing, you should decide to [get around/ obtain a license/ wait for expiration] of the patent, or quit your R&D
A company which may have a potential to use your invention	If you are a university or research organization, you may negotiate the company for collaboration or may ask for an investment.

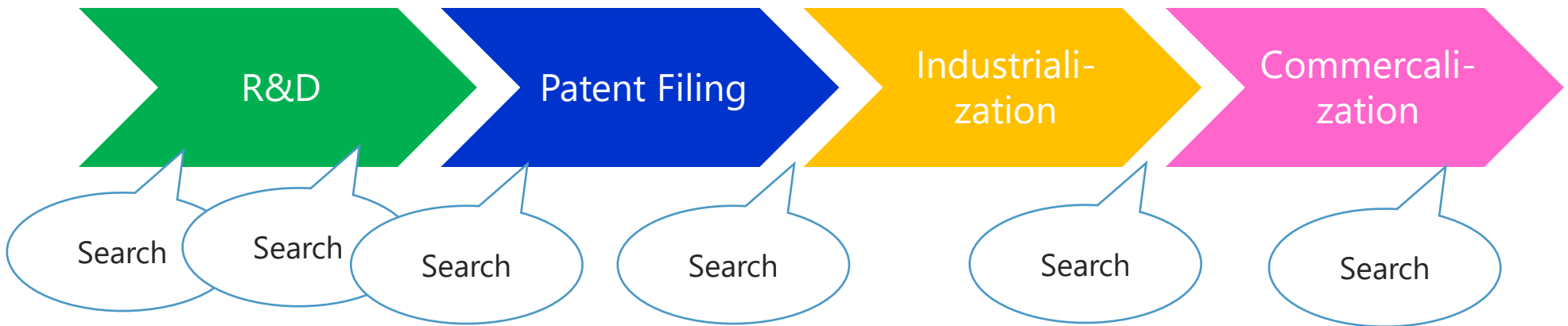
#### 4. Patent search on various Stages in R&D through commercialization, and its purpose

If you find out a blocking patent of “the raw materials for inner layer” by a raw material supplier, which material is indispensable for your invention, you need to purchase the raw materials from the third party for instance.

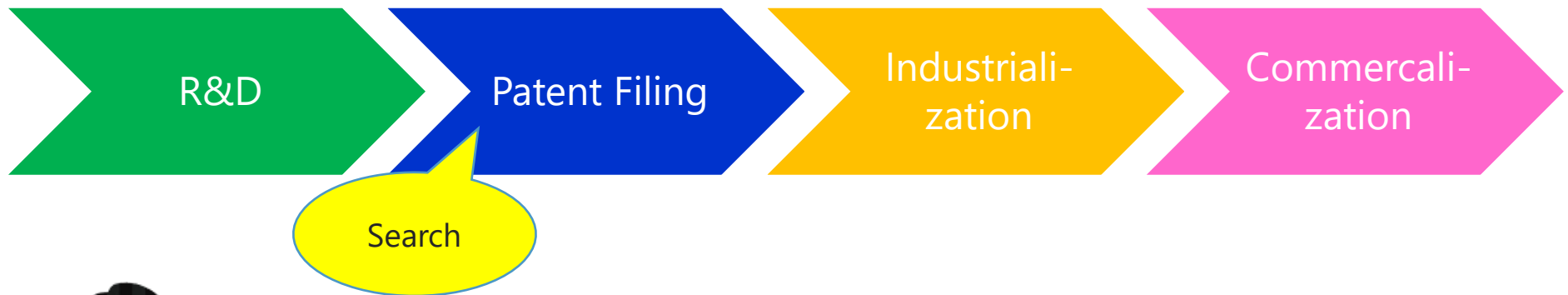


## 4. Patent search on various Stages in R&D through commercialization, and its purpose

- Patent Search is necessary in various stages of the business.



## 4. Patent search on various Stages in R&D through commercialization, and its purpose



- Patent Search is necessary before filing a patent application.



## 4. Patent search on various Stages in R&D through commercialization, and its purpose



Your R&D is completed successfully.



What would be done next?



Filing a patent application of your invention.



What if there is a third party's patent from which your invention is easily created?



Your patent application will be rejected due to the lack of inventive step.

Before the patent application of your invention, patent search is necessary.

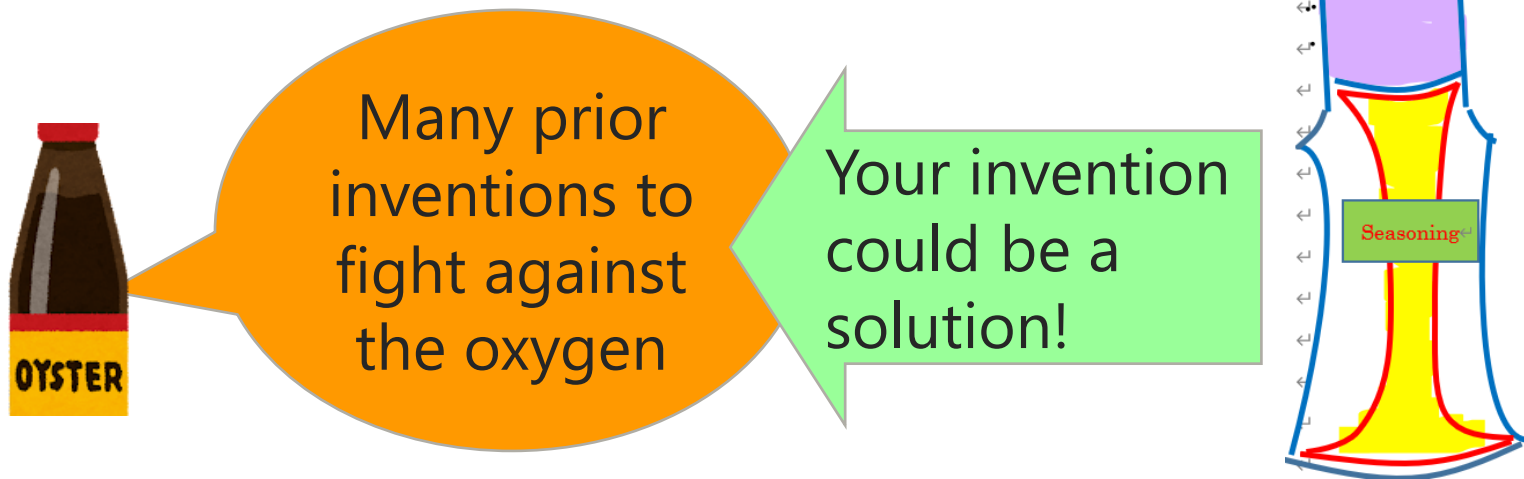
4. Patent search on various Stages in R&D through commercialization, and its purpose

Through the patent search before filing a patent application,

<b>You may find out the existence of</b>	<b>Purpose: To find out the feasibility to file a patent application for you R&amp;D</b>
The patent from which your invention is easily created	You should study the inventive steps in your invention, or the necessity to do additional R&Ds.
A possibility that your invention is used as it is	If your invention contributes for a business as it is, the invention should be adequate to file a patent application.

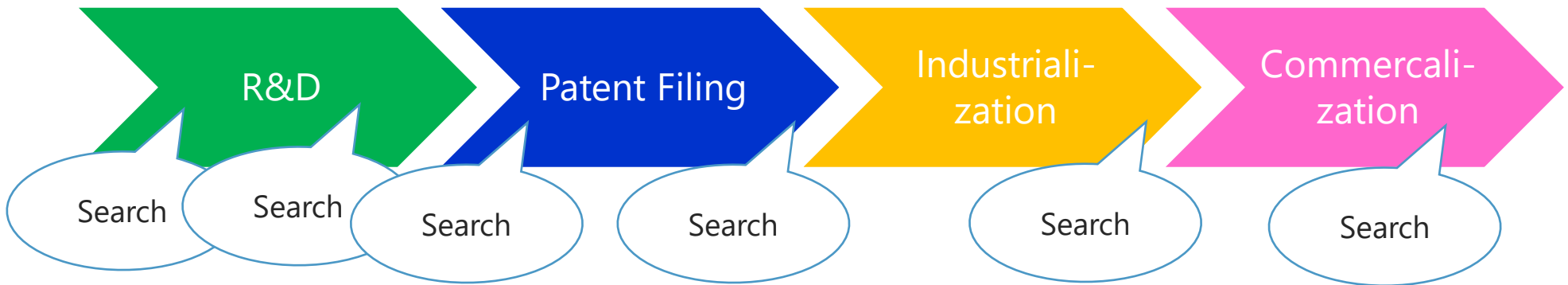
#### 4. Patent search on various Stages in R&D through commercialization, and its purpose

Suppose you find out many patents which is “the recipe of liquid seasonings which increases the tolerance to oxygen” by seasoning manufactures, your invention may be the best solution for them because the seasoning manufactures need not to change their recipe (i.e. taste).

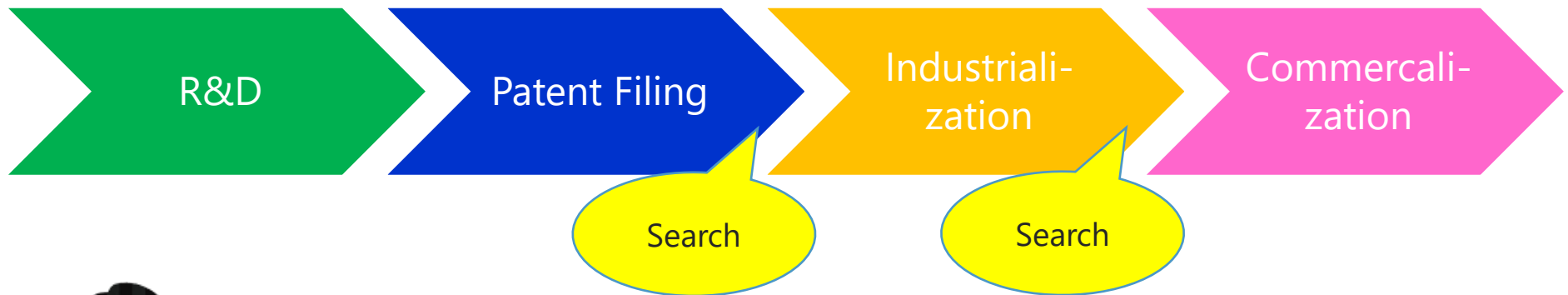


## 4. Patent search on various Stages in R&D through commercialization, and its purpose

- ▶ Patent Search is necessary in various stages of the business.



## 4. Patent search on various Stages in R&D through commercialization, and its purpose



- Patent Search is necessary before industrialization and/or commercialization (hereinafter, collectively "commercialization").

## 4. Patent search on various Stages in R&D through commercialization, and its purpose



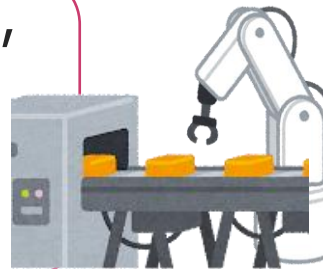
The filing of your invention is completed.



What would be done next?



Moving to business, such as industrialization or commercialization.



What if there is a third party's patent which is an obstacle of your business?



Your business is hindered.

Before moving to the business, patent search is necessary.

#### 4. Patent search on various Stages in R&D through commercialization, and its purpose

Through the patent search before commercialization,

<b>You may find out the existence of</b>	<b>Purpose: To find out the feasibility to commercialize your invention</b>
[Again] A blocking patent by a third party	<p>&lt;NOTE&gt; This is the last chance to see the feasibility to commercialize your invention.</p> <ul style="list-style-type: none"><li>➤ If commercialization would infringe third party's patent, you need to get around the patent or quit commercialization.</li><li>➤ If your business is B to B, you should also take care on the possibility of infringement of third party's patent by your customer.</li></ul>
Third party's patent on which you otherwise infringe if you commercialize your invention	

#### 4. Patent search on various Stages in R&D through commercialization, and its purpose

Suppose you find out the same patent as your invention which was filed by your competitor just before you file your invention, and it is hopeless that you would obtain a license from the competitor, quitting the commercialization would be one of the possible solutions.



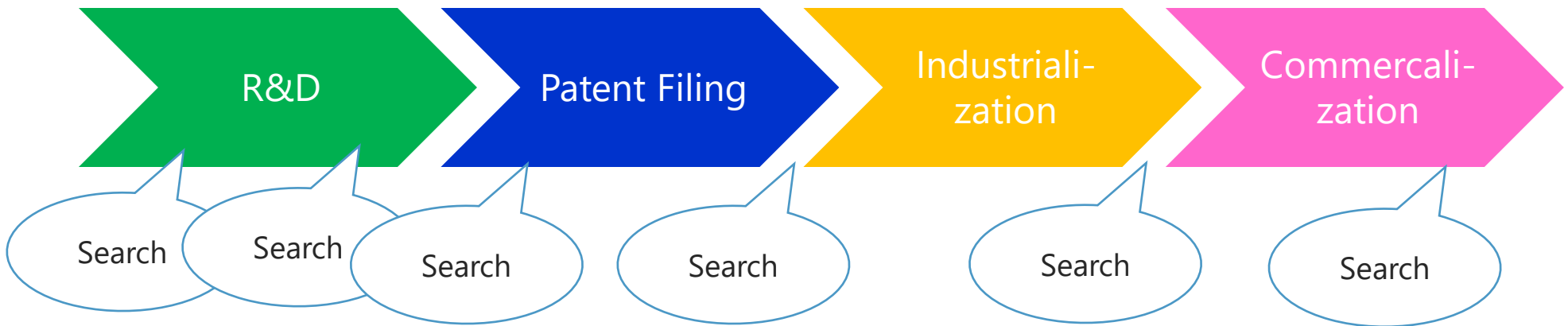
You find a competitor's patent

Sometimes the brave decision to quit the commercialization could be the best choice.



## 4. Patent search on various Stages in R&D through commercialization, and its purpose

- Patent Search is necessary in various stages of the business.



## 4. Patent search on various Stages in R&D through commercialization, and its purpose



- Patent Search is sometimes necessary before licensing your invention to a third party.

## 4. Patent search on various Stages in R&D through commercialization, and its purpose



Your application is granted as a patent.

What if a third party's patent is also necessary to use, upon implementing your invention?



What would be done next?

Value of your invention may be reduced or becomes null.



Licensing the technology to a third party.



Before the licensing, patent search **sometimes** becomes necessary.

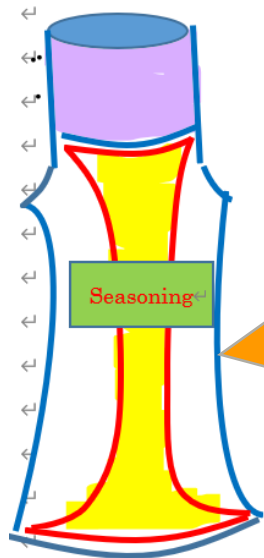
#### 4. Patent search on various Stages in R&D through commercialization, and its purpose

Through the patent search before licensing,

<b>You may find out the existence of</b>	<b>Purpose: To find out the feasibility to commercialize your invention</b>
[Again] A blocking patent by a third party	<NOTE> Please read carefully the license agreement.
Third party's patent on which licensee otherwise infringes if he/she commercialize your invention	<ul style="list-style-type: none"><li>➤ Sometimes, the license agreement contains the clause that you warrants your patent is free from infringement of third party's patent,</li><li>➤ However, the warranty may be "to the extent of your reasonable knowledge".</li></ul>

#### 4. Patent search on various Stages in R&D through commercialization, and its purpose

If the license agreement contains the warranty that your patent do not infringe third party's patent, but also contains the legend that "to licensor's reasonable knowledge".



According to the license agreement, You may conduct the patent search in the reasonable course

Sometimes exhaustive patent search may damage the value of your patent.

# Table of Contents

1. Introduction
2. What you can find out through patent search
3. Introduction of the case
4. Patent search on various Stages in R&D through commercialization, and its purpose
5. Contents of patent search
6. Closing

# Table of Contents

1. Introduction
2. What you can find out through patent search
3. Introduction of the case
4. Patent search on various Stages in R&D through commercialization, and its purpose
5. Contents of patent search
6. Closing

## 5. Contents of patent search

You may search the followings before starting R&D,

- Prior arts and the existence of the similar technologies by third parties

(If you are a university or a research organization,)

- The potential company that you may license out your technology
- The “Issues” that the potential target companies are willing to solve.
- (Sometimes) A “hint” (which may be the current existing technologies) to reach to the said solutions.



## 5. Contents of patent search

You may search the followings before a big investment for R&D,

- Prior arts and the existence of the similar technologies by third parties
- Especially, if you are a global company or your product may be exported, those in potential foreign countries.
- The existence of third party's patent which you may infringe if your invention is commercialized,
- Especially, you should take care that the way to manufacture your invented product or the raw materials thereof. (\*)

## 5. Contents of patent search

You may search the followings before a big investment for R&D,

(\* ) Such third party's patent which may be infringed includes,

- The way to manufacture the product that your invention is incorporated (e.g. the way to assemble the inner and outer layer), or the raw materials thereof (e.g. the inner layer would use an especially flexible raw materials),
- The way to use your product (e.g. if a special way to fill the seasoning without touching to the air could be necessary)

## 5. Contents of patent search

You may search the followings before a big investment for R&D,

(If you are a university or a research organization,)

- The companies that you may collaborate with,
- which collaboration may include (i) a joint research, (ii) monetary support, and (iii) otherwise giving various ideas and potential raw materials,
- And the “Issues” that companies may have, which are not easy to resolve, but which you may have the possibility to solve.

## 5. Contents of patent search

You may search the followings before filing a patent application

- The existence of similar technologies which have been patented or otherwise published by a third party,
- The purpose of which is to know your technology's (i) novelty and inventive steps, (ii) relative strongness, weakness, and (iii) sometimes necessity to conduct additional experiment.
- The existence of third party's technologies which the product incorporating your technology would use or which the third party would use your technology,
- The purpose of which is to evaluate the possibility to perform a collaboration with the third party.

## 5. Contents of patent search

You may search the followings before commercialization,

The existence of a third party's technology, including the same or similar technology as/to your invention,

Where,

- The existence of a blocking patent by a third party should be searched
- The existence of third party's patent on which you otherwise infringe if you commercialize your invention should be searched

## 5. Contents of patent search

You may search the followings before commercialization,

The existence of a third party's patent, that is necessary to be used by your customer, if your business is B to B, even though the sales of your product itself do not directly infringe the third party's patent, because

- If your customer is under the risk to be sued by the third party, due to the infringement of that third party's patent, your product may not sell enough,
- Your customer may request you to warrant that the use of your product does not infringe third party's patent, and
- You should have a risk that you indirectly infringe that third party's patent.

# Table of Contents

1. Introduction
2. What you can find out through patent search
3. Introduction of the case
4. Patent search on various Stages in R&D through commercialization, and its purpose
5. Contents of patent search
6. Closing

# Table of Contents

1. Introduction
2. What you can find out through patent search
3. Introduction of the case
4. Patent search on various Stages in R&D through commercialization, and its purpose
5. Contents of patent search
6. Closing



## 6. Closing

- Anyhow, if you find out any possibility that you, your customer or your licensee would infringe third party's patent, it is important to think of
  - i. The way to design around third party's patent,
  - ii. Purchase the third party's raw materials or products,
  - iii. Obtain a license to use the patent,
  - iv. Or otherwise

## 6. Closing

- Not all of the companies perform the patent information search at every timing mentioned in this seminar.
- Also, there may be another stages where patent information search is conducted. For instance, (i) the search to know the recent trend of R&D that the competitors are performing, in order to obtain a new concept for your business, or (ii) to find out any possibility to improve your products after the launch of the current product.
- It is also worth mentioning that the person in charge of patent should take a close communication with the person in the business section and R&D section, for the preparation of the necessary patent information search.

Thank you for your participation!



# Utilizing Intelligence of patent information for Business

**7 June 2023**

**Fumihiko Moriya**

Visiting Professor, Kanazawa Institute of Technology

Toranomon Graduate School



F. Moriya's LinkedIn information

## Key takeaways for this session

1. Utilize patent search information to strengthen business strategy. (Prior art search of new invention, FTO, design around, invalidation and Technology trend analysis)
2. Define intellectual property strategy based upon business strategy.
3. Protect differentiating technology and revenue model by intellectual property.
4. Backcasting: First, define the Long-term Vision of business.

# Revenue Model

## Subscription

- Fix payment for a period
- Netflix, Adobe, Microsoft 365

## Freemium

- Fee to enter and charging
- Spotify

## Fee for Service

- Pay per use
- Xerox

## Advertising

- Advertiser pays and users free
- Google AdWords, Facebook

## Razorblade

- Profit from consumable supplies
- Razorblade, NESPRESSO

# Advertising Revenue Model (double sided market)

**free service to users**

(Google search, Android etc.)

(Google AdWords)

**advertisers pay**

# Razorblade revenue model



**Razor cartridge  
(consumable supplies)**

Once customers purchase shaving system, they are locked in. Those customers continue to buy interchangeable razor cartridges.

pictures from Gillette  
<https://www.gillette.sg/en-sg>  
© 2022 Procter & Gamble



# Razorblade revenue model

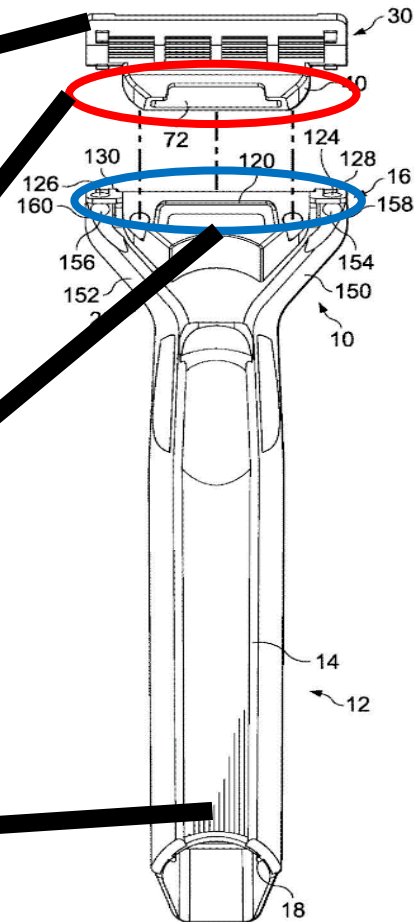
## Which part of patent is most important?

1. shaving blade

2. interface at cartridge

3. interface at holder

4. shaving holder



# Razorblade revenue model



1. In razorblade revenue model consumable razor cartridge generates profit most.
2. No third parties should be allow to sell interchangeable razor cartridges.
3. **Protection by intellectual property is essential.**

A. Patent (or simple patent)

B. Design Patent

C. Trademark (Three dimensional mark)

picture from Gillette

<https://www.gillette.sg/en-sg>

© 2022 Procter & Gamble

# Protect Differentiating technology

**Patent Search is essential to evaluate  
patentability of new invention for  
consumable supply.**

# Differentiating technology

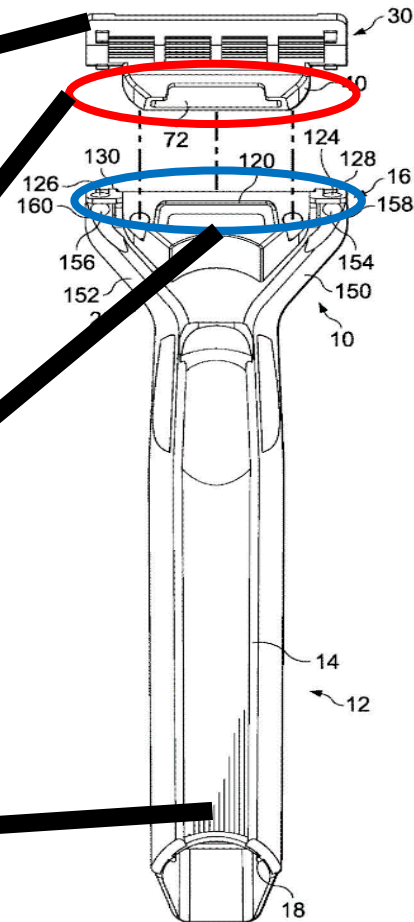
Which part of patent is most important?

1. shaving blade

2. interface at cartridge

3. interface at holder

4. shaving holder



# Razorblade revenue model Inkjet printer



**“Business competition” is not racing.**



**With the patent of differentiating technology you don't have to join price competition race of commodity products.**

# Profitable business operation

## Patent Search is essential

- **Patentability of new invention for differentiating technology**  
→ **protect exclusivity of its business**
- **Freedom to operate (FTO)**  
→ **avoid patent infringement**

# Patent Infringement

**Patent Search is essential to avoid patent infringement.**

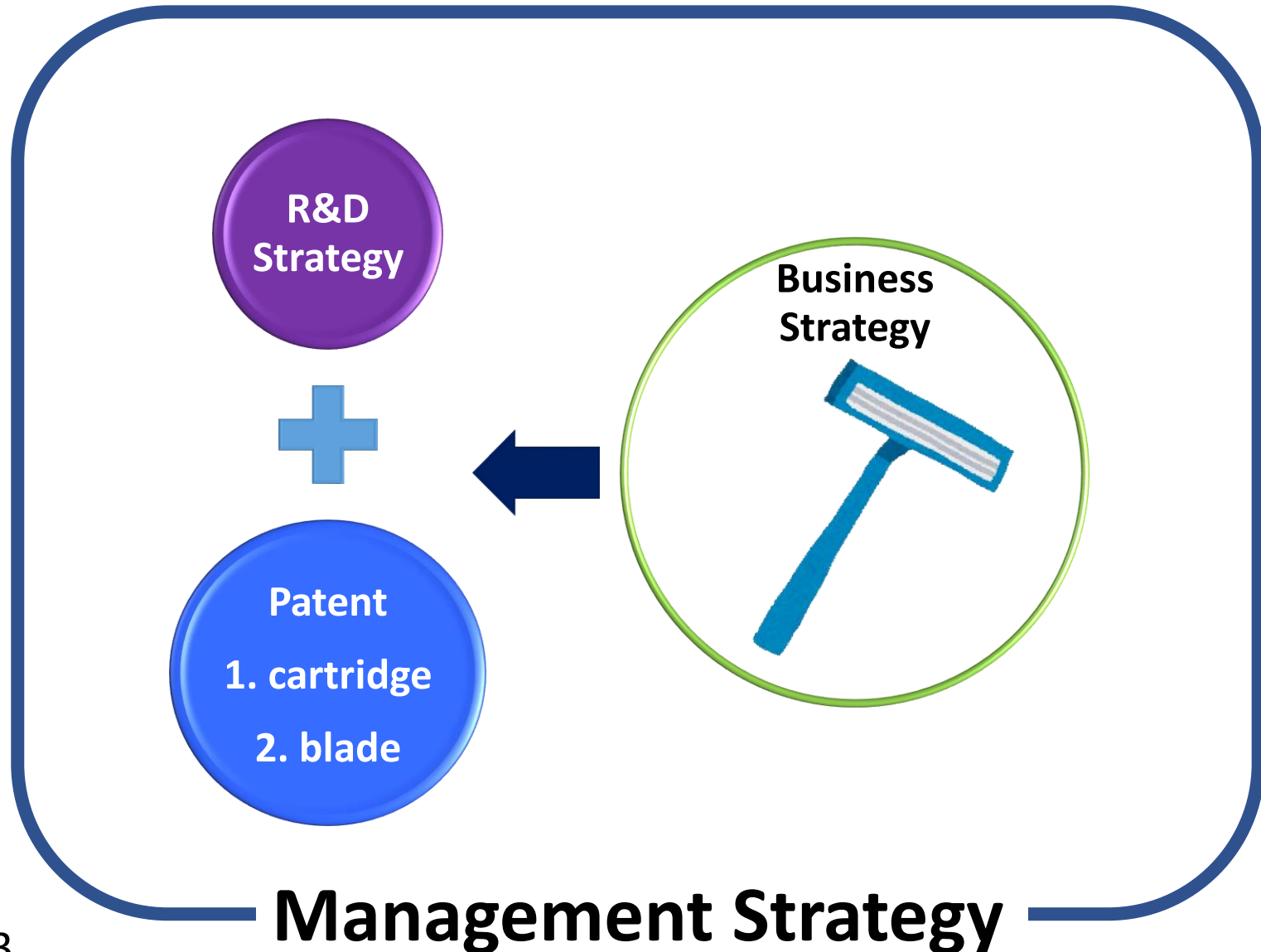
- **Freedom to operate (FTO)**
- **non-infringement argument**
- **Invalidation of the patent**
- **Viability of your patent**



# How can patent infringement be avoided?

1. Giving up selling products
2. Preparing for non infringement argument
3. Invalidating the patents
4. Designing around
5. Buying out the patents (patent owner company)
6. Buying licensed products from owner/licensee
7. Obtaining a license
  - A) unilaterally licensed
  - B) cross license

First create business strategy by analysing environment.



## Against two types of your competitors

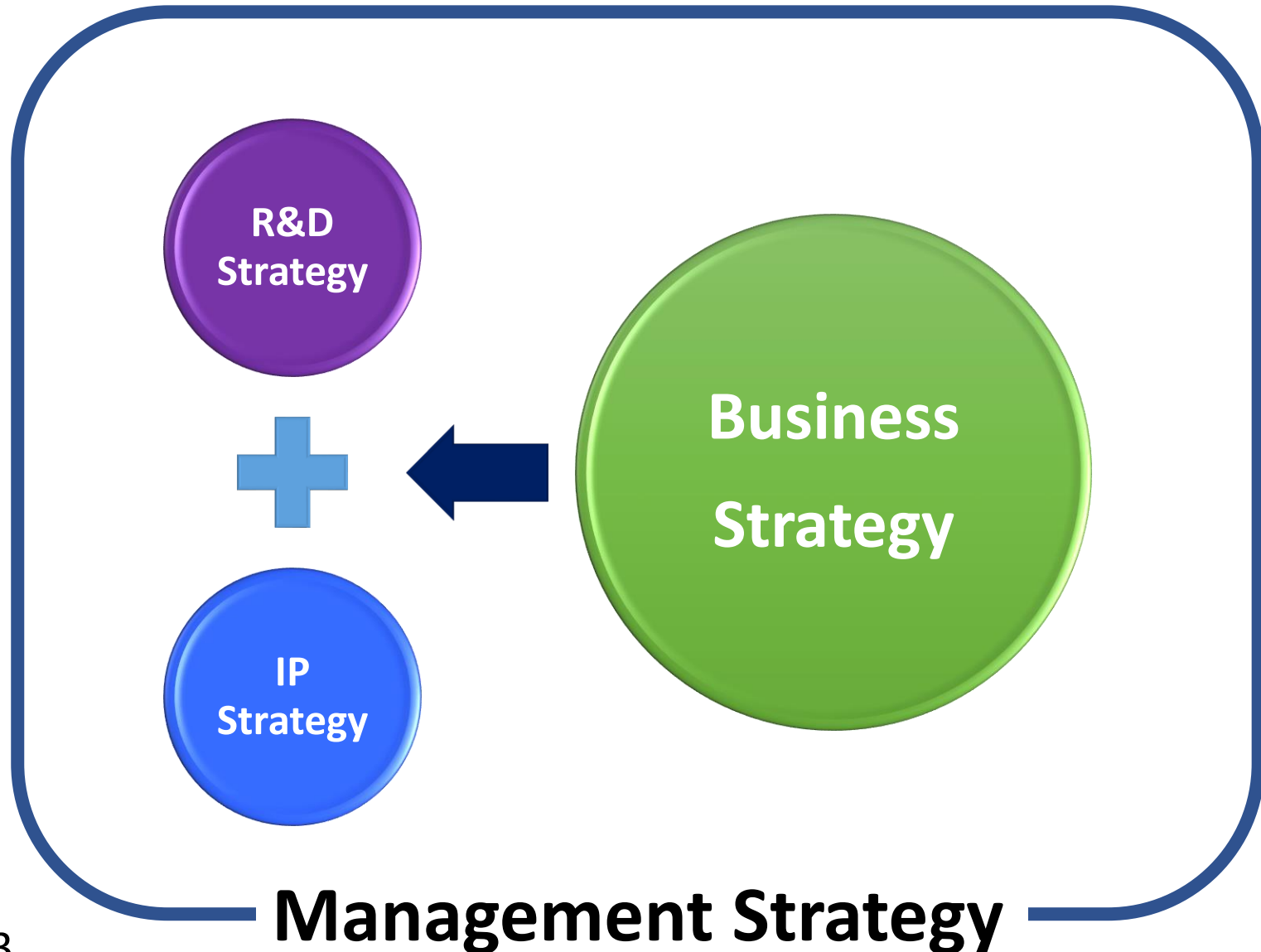
### Cartridge

- Create design and patent to exclude compatible cartridges

### Razor blade

- Create better razor blade system
- Protect your technology by patent

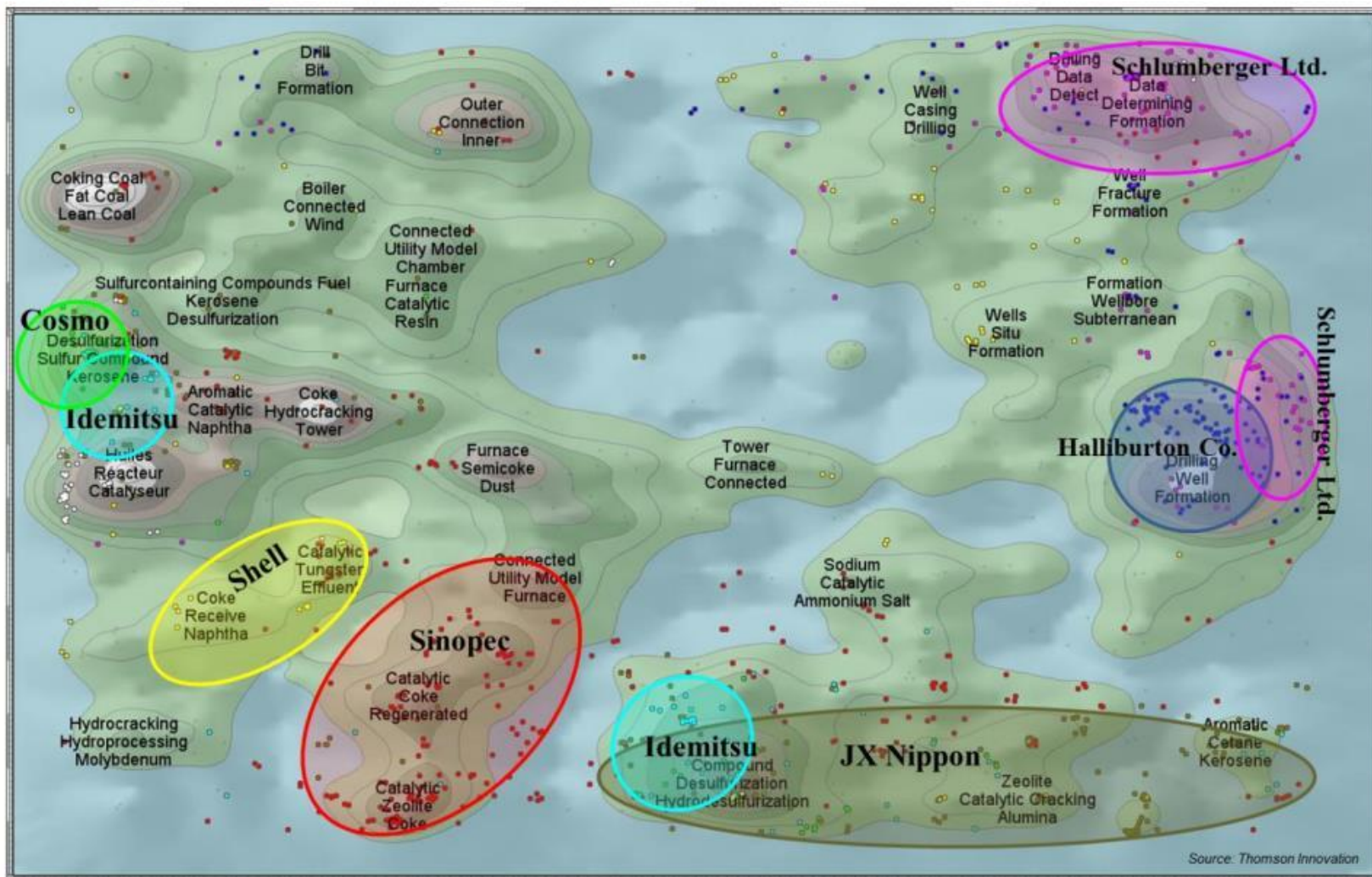
**First create business strategy by analysing environment.**



# IP Landscape

**Figure 7: Patent landscape map highlighting regions of research for top applicants**  
**To read this map**

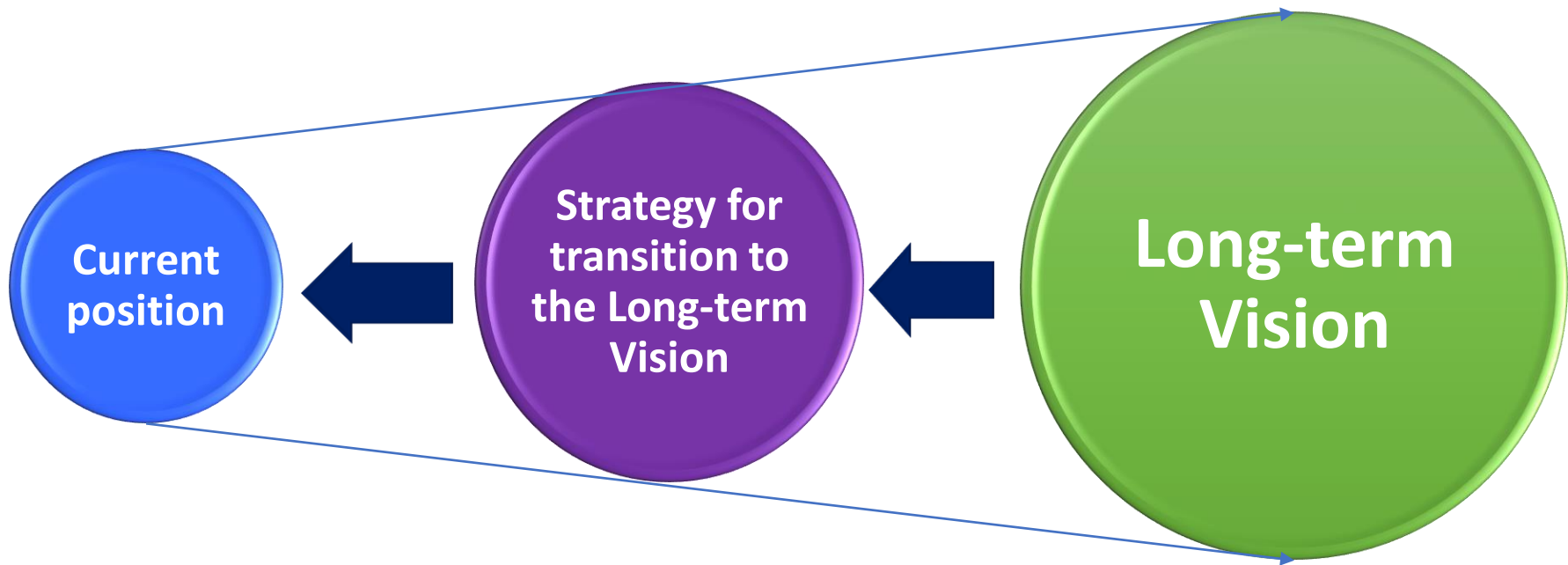
The English translation of the wording is provided in a table below the map.



# SWOT analysis with Patent Search

	positive to target	negative to target
<b>Internal Factors</b> <ul style="list-style-type: none"><li>• Capabilities</li><li>• Resources</li><li>• Structure</li><li>• Manpower</li><li>• Finances</li></ul>	Strength <b>S</b>	Weakness <b>W</b>
<b>External Factors</b> <ul style="list-style-type: none"><li>• Market trends</li><li>• New competitor</li><li>• Consumer preference</li><li>• <b>Patent Search (IP Landscape)</b></li></ul>	Opportunities <b>O</b>	Threats <b>T</b>

# Backcasting



- 10 years later  
**business strategy**
- R&D strategy
  - ideal patent portfolio

# Patent Exhaustion in products with consumable parts

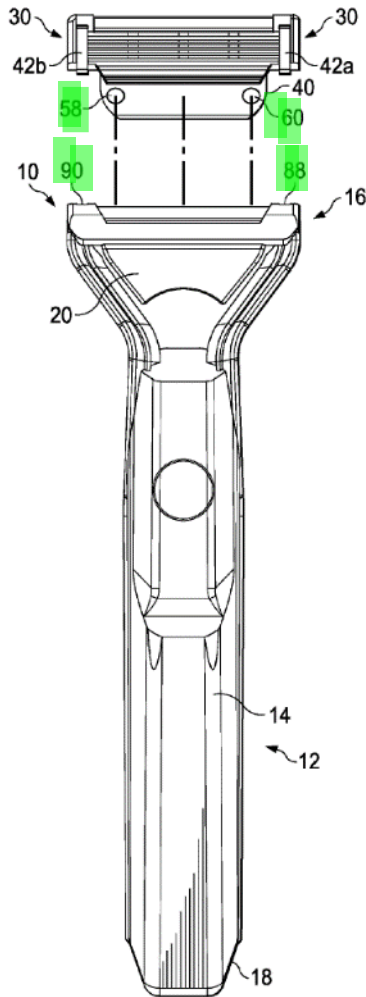


FIG. 5A

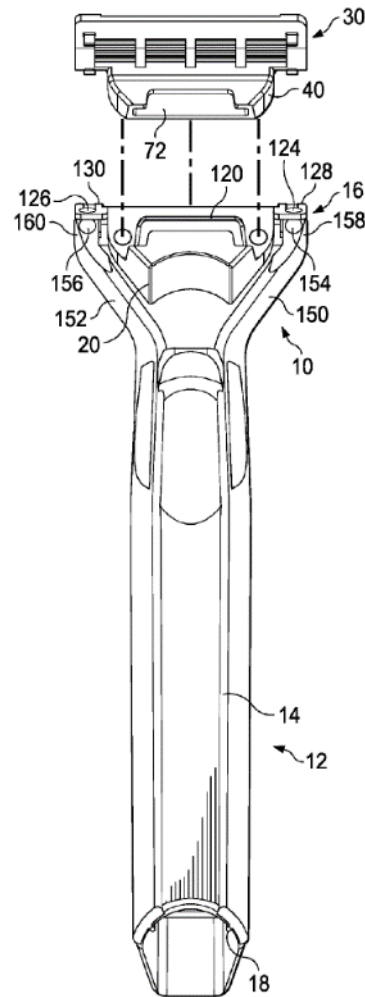


FIG. 5B

For example the patent claiming elements of 58, 60, 90 and 88 would be exhausted, if the patent owner sells razor holder.



# Tips

## Avoiding patent exhaustion for razor cartridges

1. Patent cartridge and holder separately.
2. Design the interface of cartridge with a standalone novel feature.  
  
e.g. Create a patent claim for elements of 58, 60 and 72 with standalone novel feature.

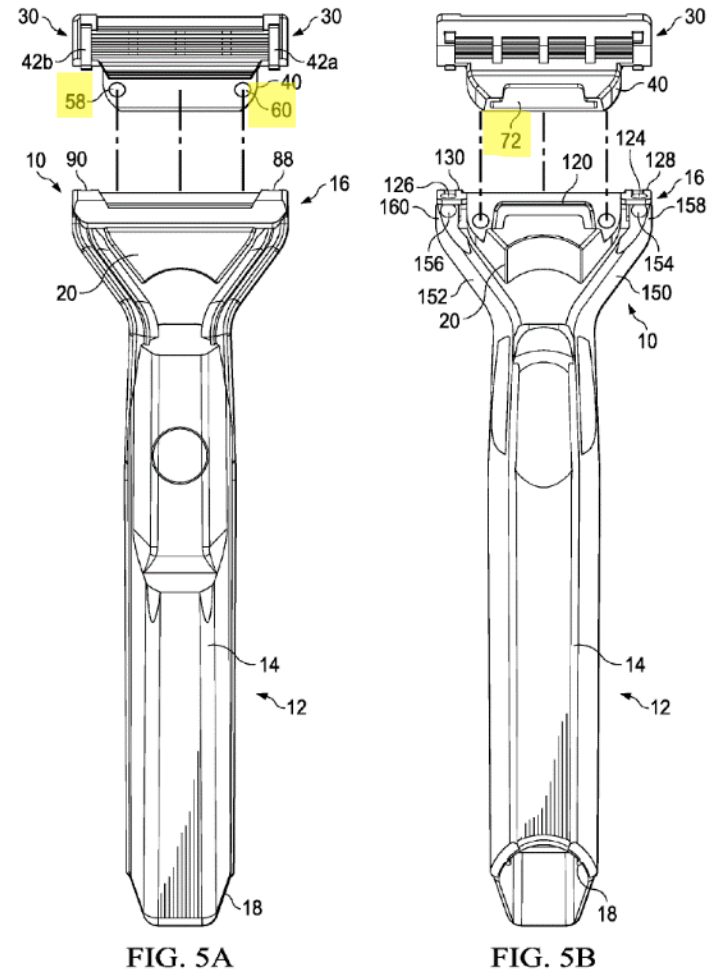


FIG. 5A

FIG. 5B

## Summary: Purpose of Patent Search

1. Obtaining patent: Prior art search for new invention
  2. Avoiding patent infringement
    - a) FTO (Freedom to operate)
    - b) design around
    - c) invalidate third party patent
  3. Analysing technology trend and competitors
- Create a proper Patent Search Strategy for you purpose.



# Intellectual Property Strategy needs longer future vision



## Key takeaways for this session

1. Utilize patent search information to strengthen business strategy. (Prior art search of new invention, FTO, design around, invalidation and Technology trend analysis)
2. Define intellectual property strategy based upon business strategy.
3. Protect differentiating technology and revenue model by intellectual property.
4. Backcasting: First, define the Long-term Vision of business.



**Thank you for your attention!**

# Lecture and demonstration on patent information searching

June 7<sup>th</sup>, 2023

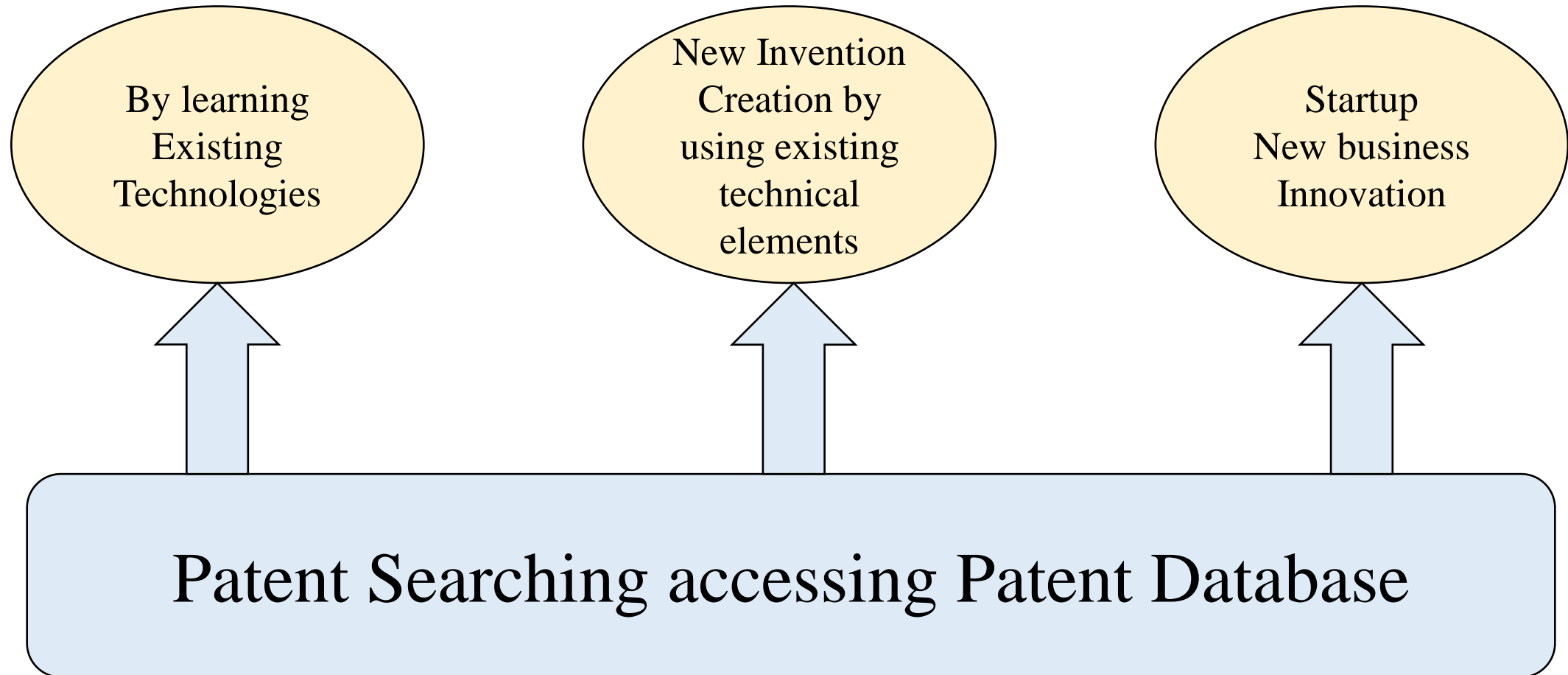
Yoshitoshi Tanaka

ERIA WG Leader

Professor Emeritus, Tokyo Institute of Technology

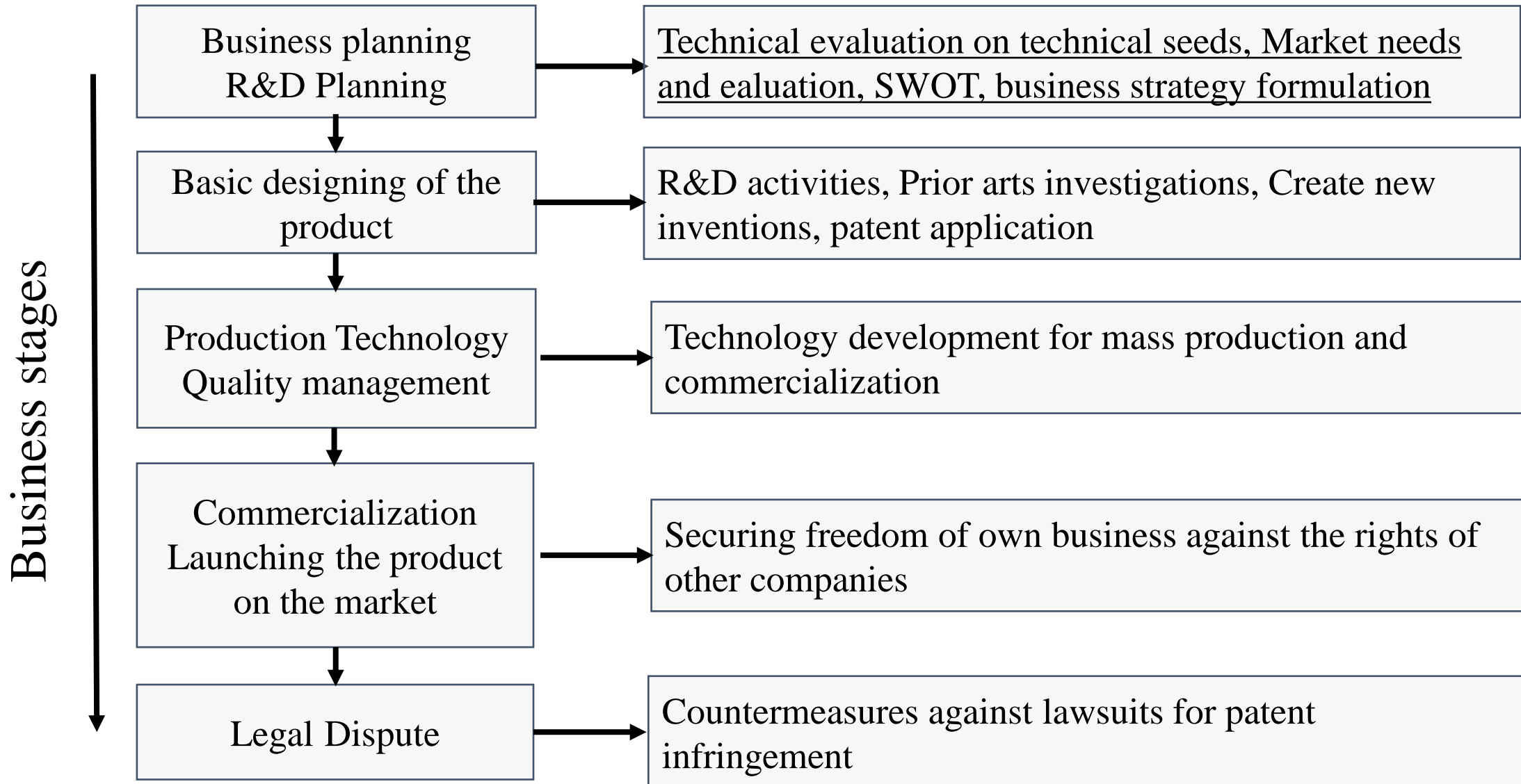
- ✓ Why we need patent searching?
- ✓ How we can utilize patent information?
- ✓ What kind of patent search will be our target today and tomorrow?

# Patent Searching is definitely indispensable for future industry's growth!

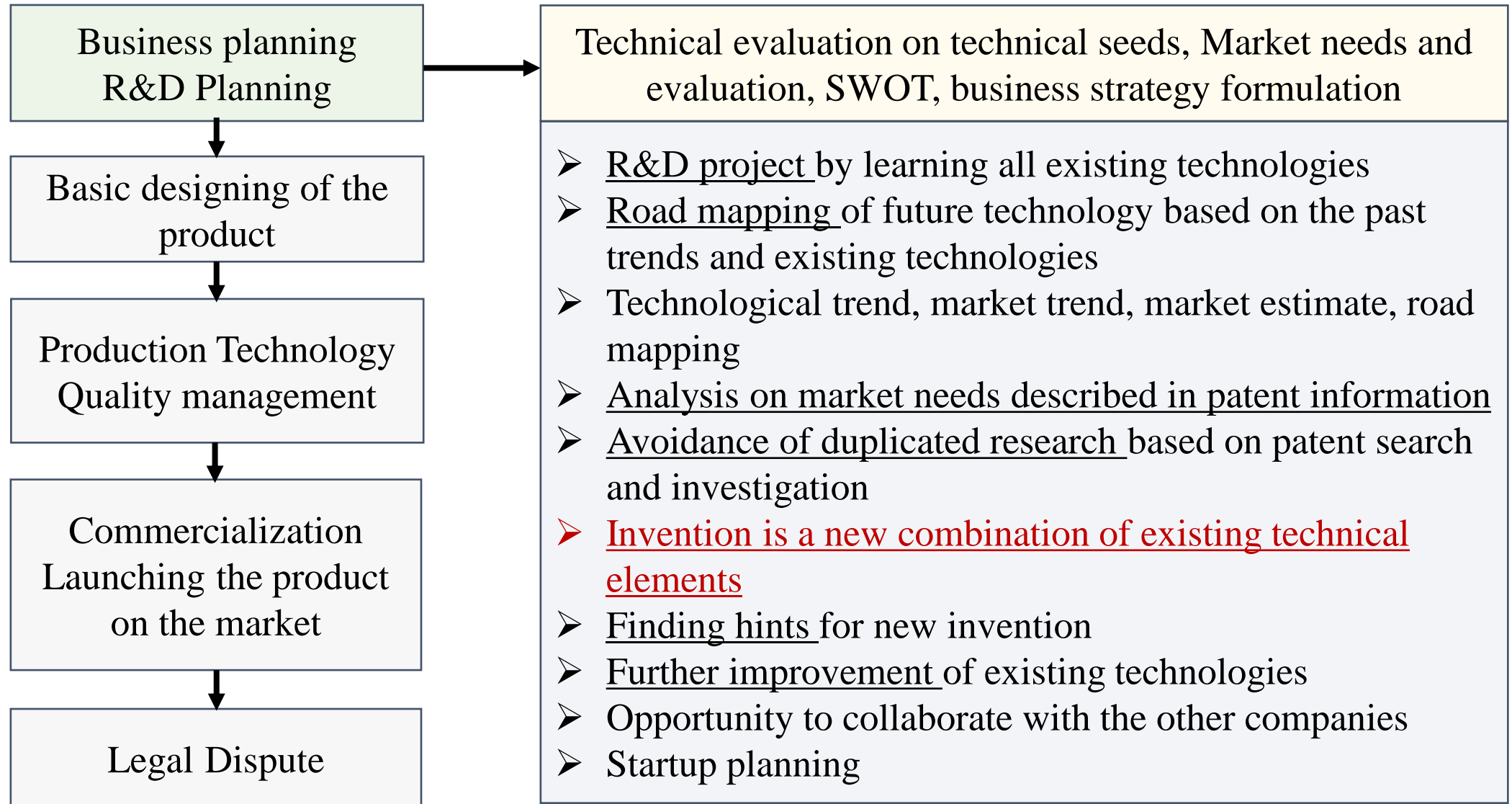




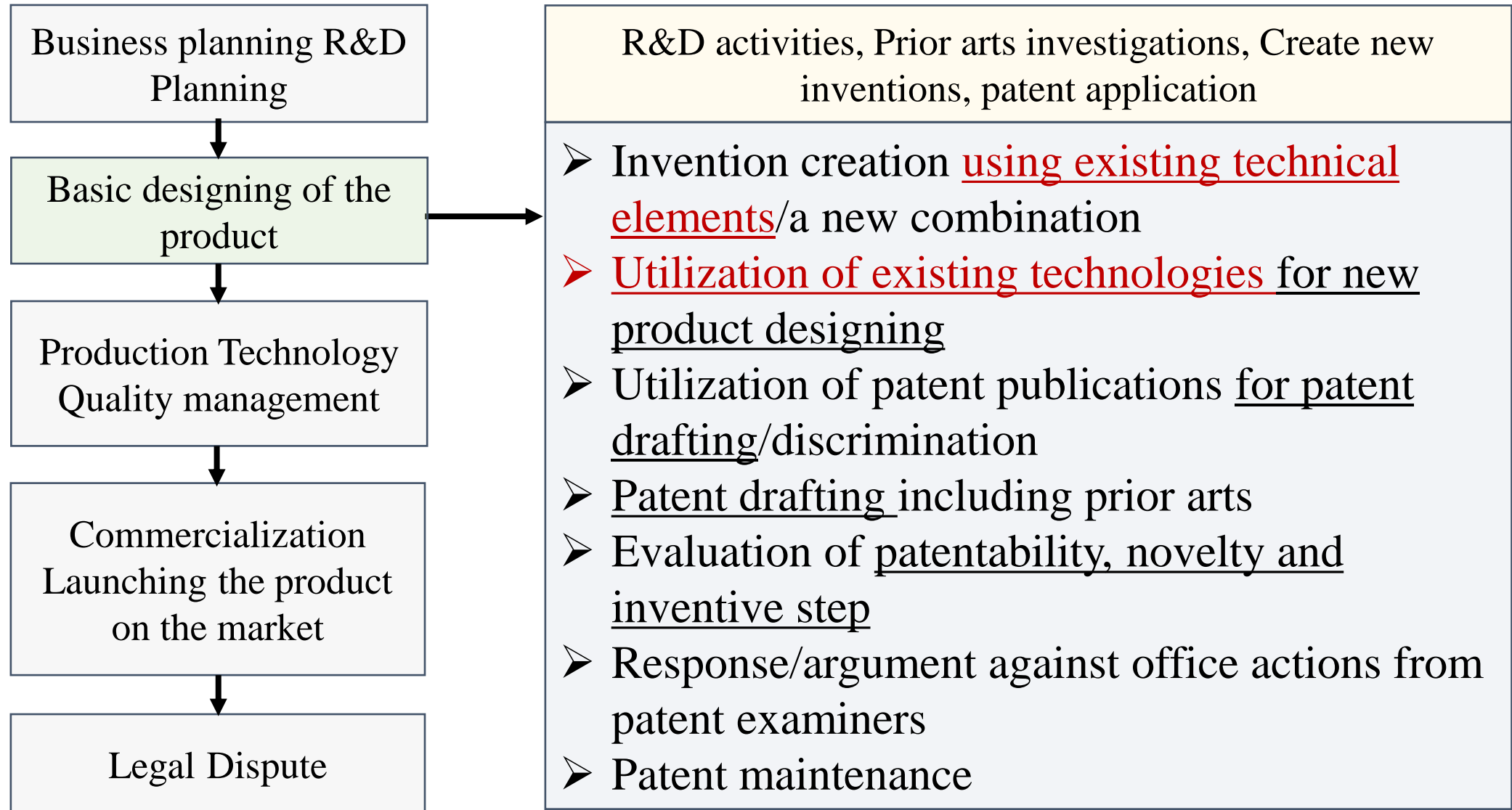
# Patent search along with business stages



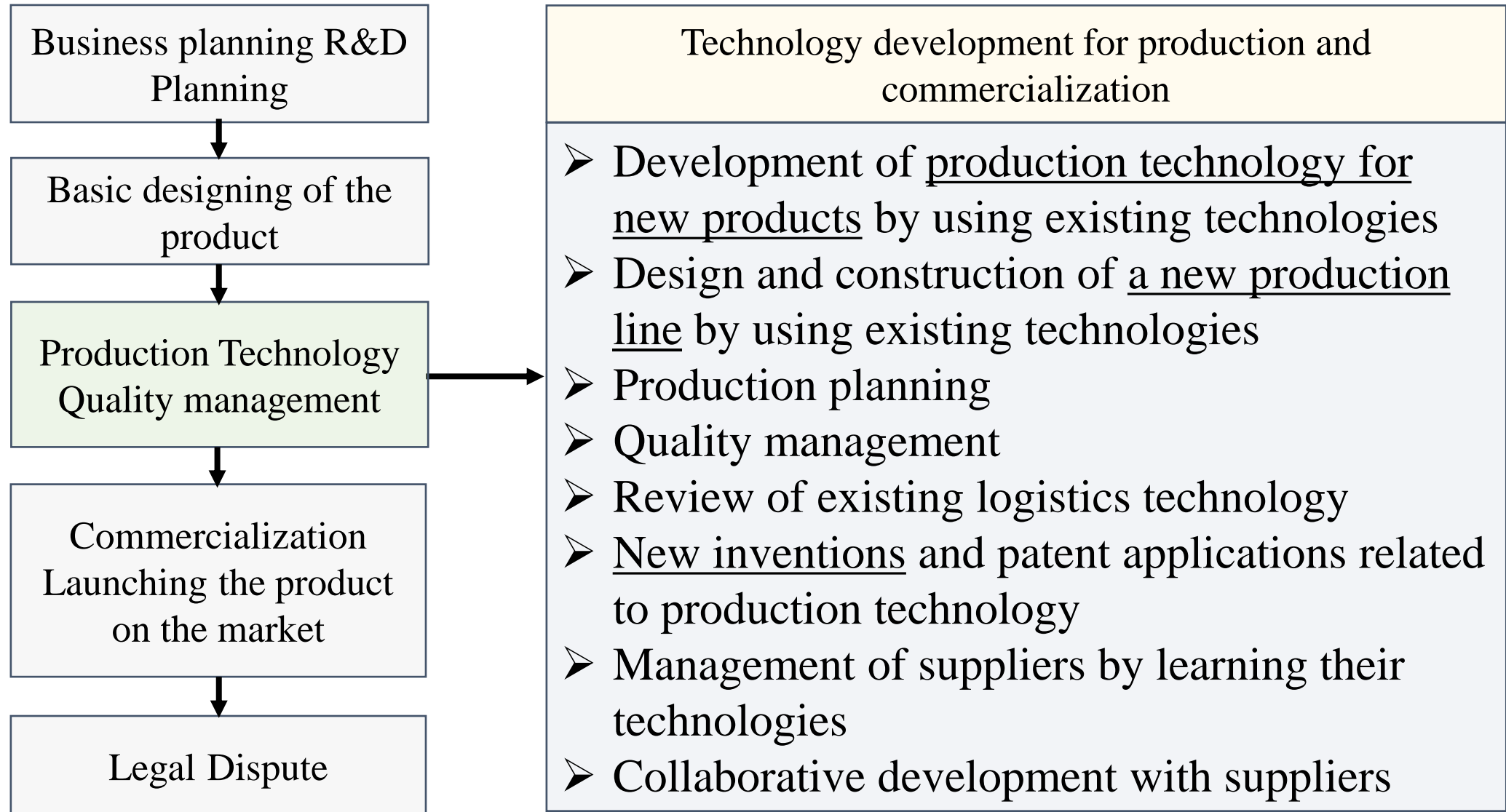
# Patent search along with business stages



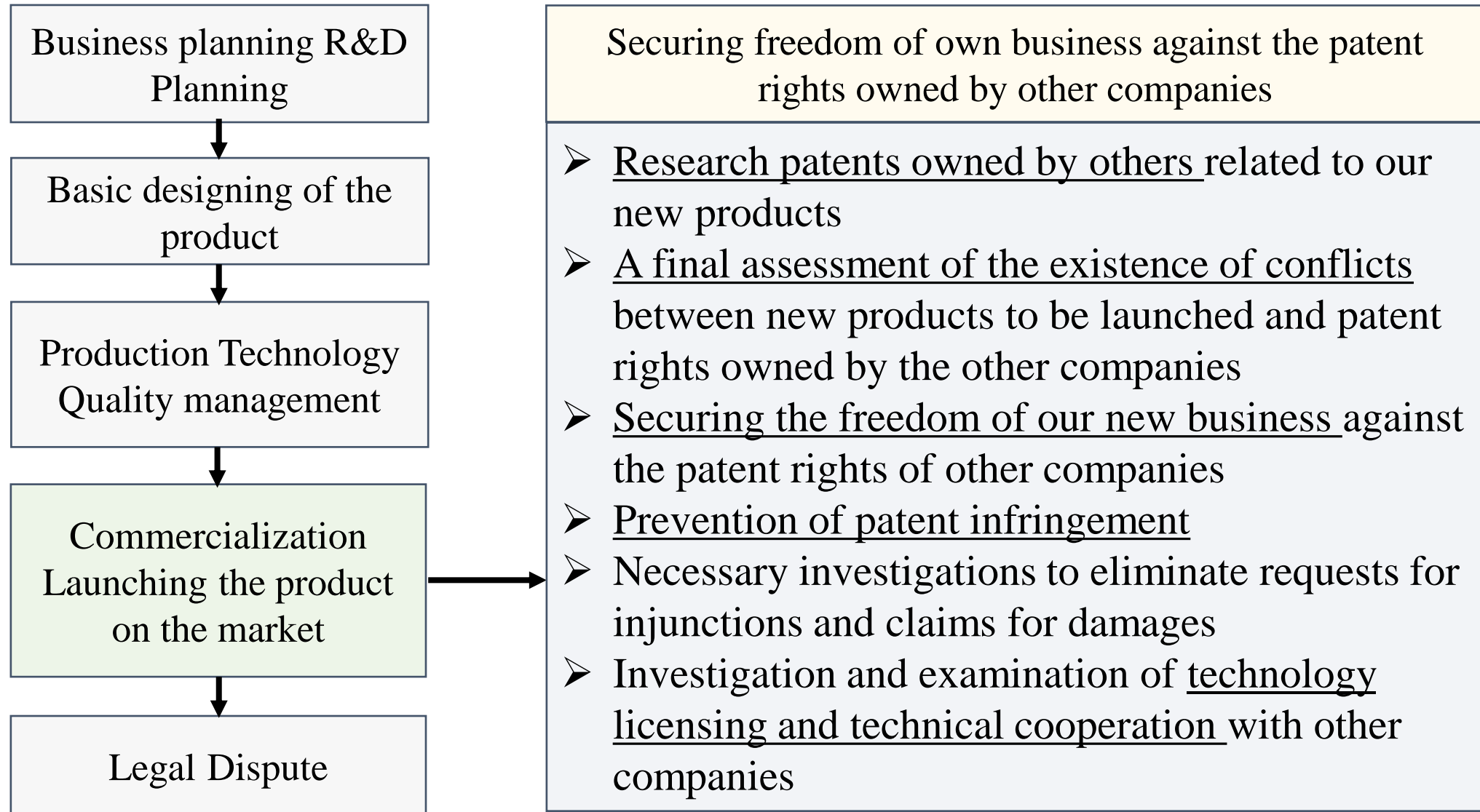
# Patent search along with business stages



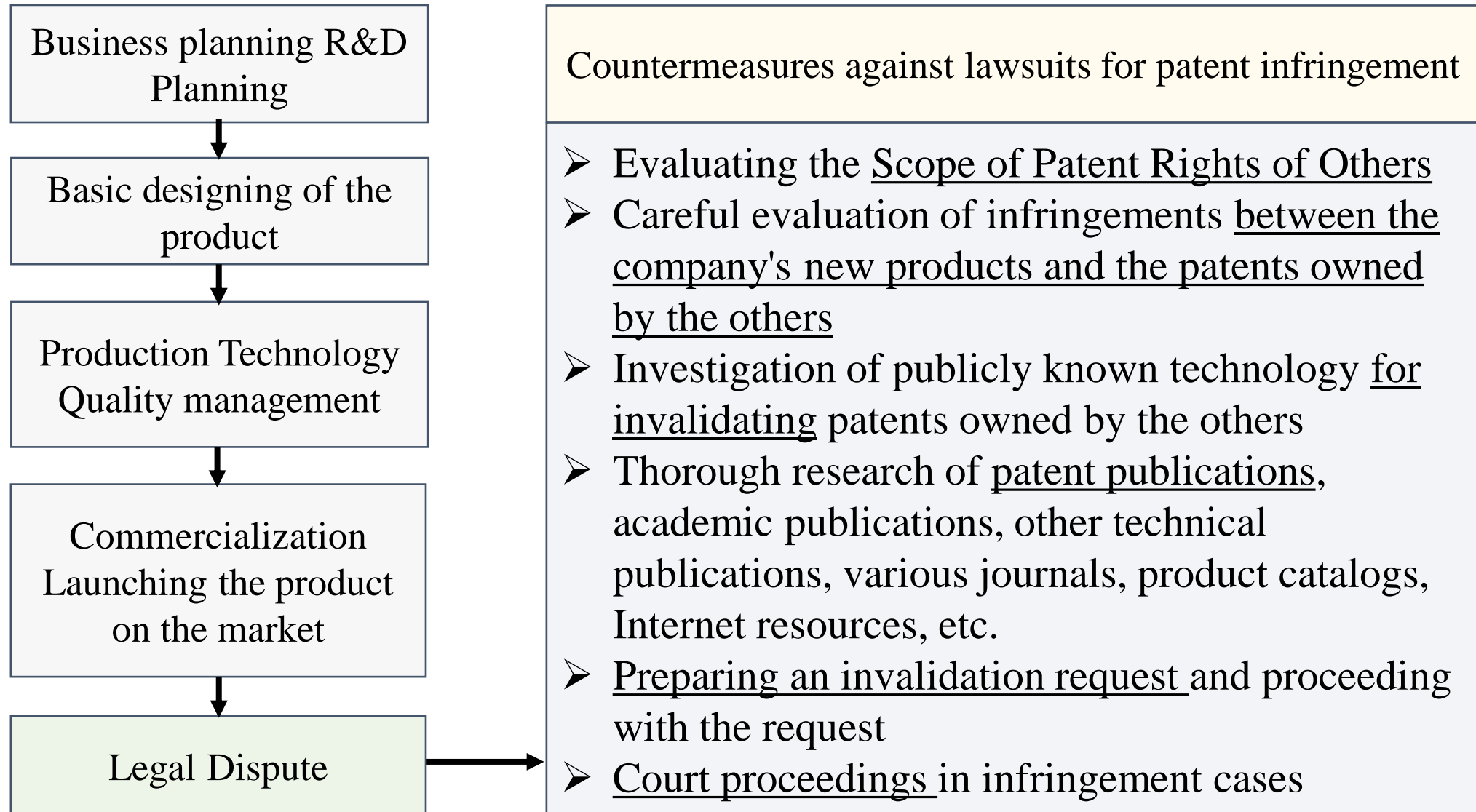
# Patent search along with business stages



# Patent search along with business stages



# Patent search along with business stages



# Basic Idea of Patent Searching

## Basics of creating a search formula

Unlike Internet search systems, **patent databases require the creation of search formulas** for searching.

Internet search systems take into account synonyms and spelling variations to some extent. On the other hand, **patent databases are searched under specified conditions of keywords.**

In order to avoid omissions in search and strengthen narrowing down, it is necessary to add the same concept (using OR) or multiply different concepts (using AND). Understand how to use “OR” and “AND”.

*(bad example)*

(mobile phone OR communication) AND (smartphone OR liquid crystal)

Before searching, first, it is important to understand the content of the invention accurately. Make sure you **understand the content of the search target technology** that we propose to you. And, **create a search formula** based on that understanding.

The evaluation of the quality of the search results is that there are no omissions in the search, effective narrowing down is possible, and there is little noise.

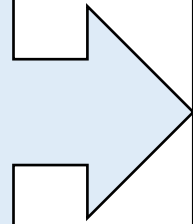
The search target technology shall be slightly abstracted (upgraded) to define search keywords.

In addition to keyword searches, it is also important to utilize patent classifications. The use of patent classifications covers synonyms, etc., and compensates for the shortcomings of keyword searches.



# Our Target Objectives

We don't know the specific number of publication.  
We **like to know all** concerned specific technologies



Specific Technology Searching by using key words, etc.

If we know the specific number of publication, just do the simple search by using Specific Publication Number. This is not our jobs today.

# How we can extract key words from the technical subject for patent searching?

To make technology searching, first we have to define “What is the technical subject for searching?”

We have to understand the invention clearly by using technical elements, [A, B, C, D, E].

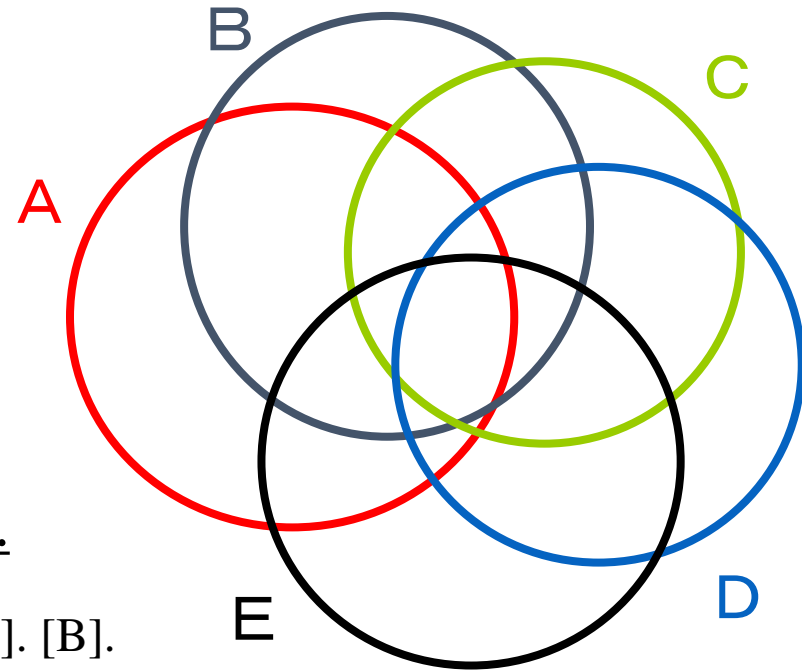
We make specific technology searching using technical key word; **simple/multiple key words, IPC.**

[A, B, C, D, E]. [A, B, C, D]. [A, B, C]. [A, B]. [B, C, D]. [C, D, E]. [A]. [B]. [C]. [D]. [E].

If we find [A, B, C, D, E], lack of novelty.

If we find some combination like [A, B, C]+[C, D, E], lack of inventive step.

→Variation for searching; [A, B, C, D]+[D, E], [A, B]+[B, C, D, E], etc.



# Patent Search using Espacenet

This database is provided by the EPO. A leading free database for foreign patent searches.

<https://worldwide.espacenet.com/>

We recommend using Espacenet for this contest, as it is easier for beginners to use.

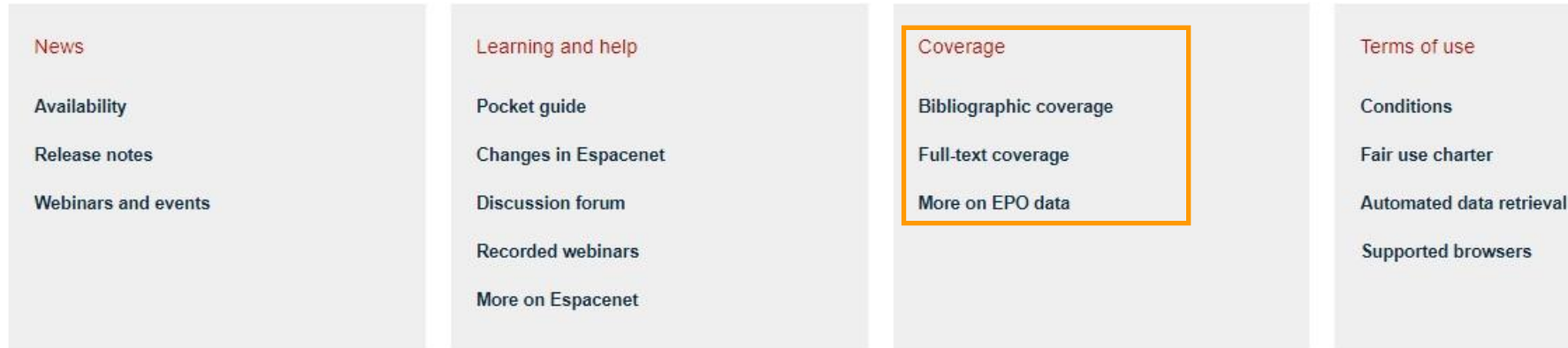


**Espacenet: free access to over 120 million patent documents**



Espacenet enables bibliographic searches in more than 100 countries and institutions around the world, and full-text searches in countries with full-text content (more than 60 countries and institutions).

## About Espacenet



- [Espacenet - patent search](#)
- [European Publication Server](#)
- [Searching Asian documents](#)
- [EP full-text search](#)

### Bibliographic coverage in Espacenet and OPS

Warning! We are currently experiencing server problems. We apologize for the temporarily missing data and any inconvenience caused.

The table below, which is updated daily at 15.00 hrs CET, provides the most recent snapshot of Espacenet and OPS bibliographic coverage.

Coloured rows indicate that the data has changed compared to the previous day. The details of the changes are indicated in green. If a new row of data is created, all entries are in green. If gaps in coverage are filled without any change of the first/latest publication, only the total number of documents is in green.

Snapshot date: 12.8.2021 / Total count: 130.400.285

Show only changes

Country code	Kind	First publication	Latest publication	Total coverage
AM	A	2001-05-10 AM949A2	2006-09-15 AM1813A2	4
AM	U	2009-10-26 AM170U	2010-04-26 AM194U	2

- [Espacenet - patent search](#)
- [European Publication Server](#)
- [Searching Asian documents](#)
- [EP full-text search](#)

### Full-text coverage in Espacenet

Warning! We are currently experiencing server problems. We apologize for the temporarily missing data and any inconvenience caused.

The table below, which is updated daily at 15.00 hrs CET, provides the most recent snapshot of Espacenet full-text coverage.

Coloured rows indicate that the data has changed compared to the previous day. The details of the changes are indicated in green. If a new row of data is created, all entries are in green. If gaps in coverage are filled without any change of the first/latest publication, only the total number of documents is in green.

Snapshot date: 12.8.2021 / Total count: 105.026.099

Show only changes

Country code	Kind	Language	First publication	Latest publication	Total coverage
AP	A	English	1985-07-03 AP1A	2005-04-21 AP1368A	1 377
AT	A	German	1975-01-15 ATA500273A	2018-05-15 AT519234A4	13 033



Europäisches  
Patentamt  
European  
Patent Office  
Office européen  
des brevets

Press

Contact us

Search

Website

Patents

English ▾

Home

Searching for patents

Applying for a patent

Law & practice

News & events

Learning

About us

Searching for patents ^

European Patent Register

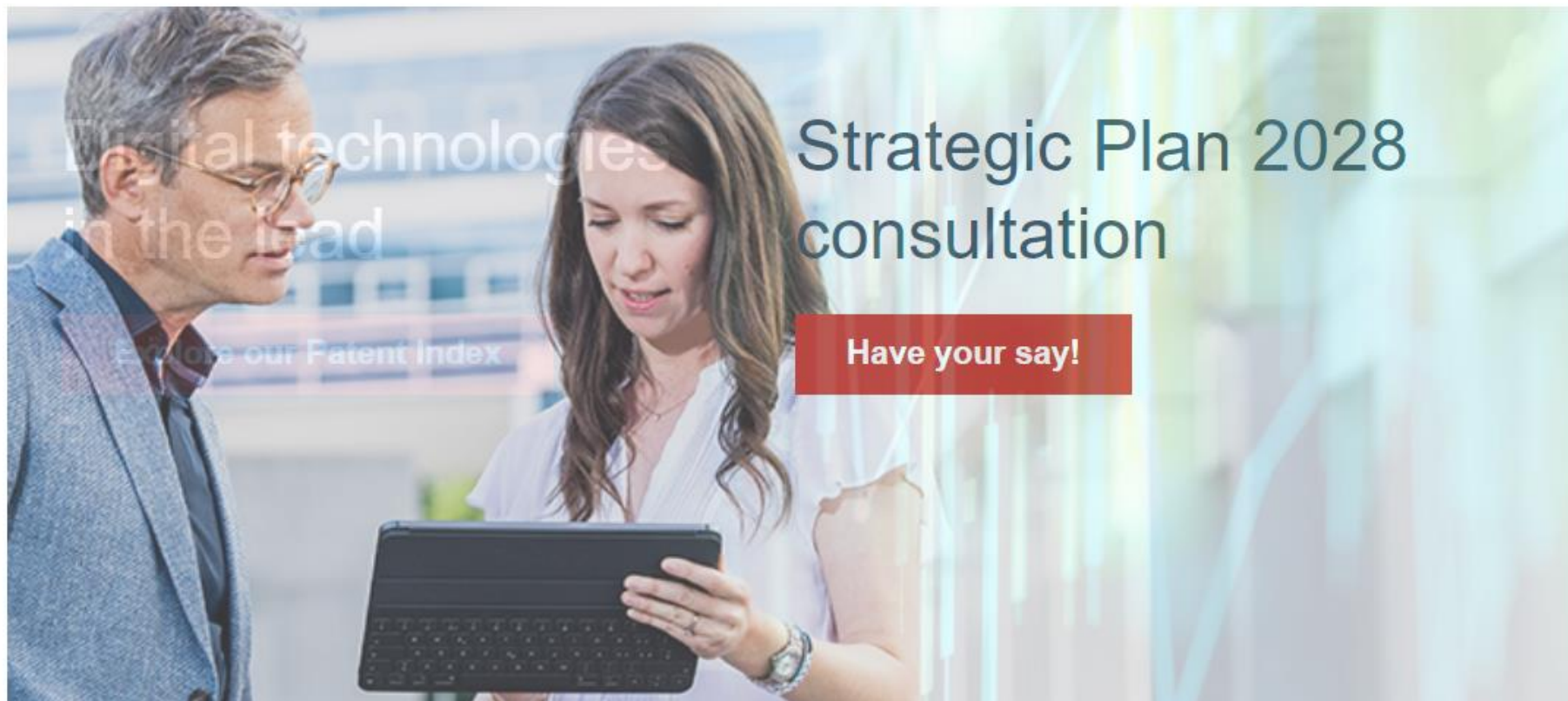
European Publication Server

Espacenet - patent search

Patent Translate

Patent Knowledge News

Applying for a patent ▾



Strategic Plan 2028  
consultation

Have your say!





Europäisches  
Patentamt  
European  
Patent Office  
Office européen  
des brevets

[Press](#)

[Contact us](#)

[Website](#)

[Patents](#)

[English](#) ▾

[Home](#)

[Searching for patents](#)

[Applying for a patent](#)

[Law & practice](#)

[News & events](#)

[Learning](#)

[About us](#)

[Home](#) > [Searching for patents](#) > [Technical information](#) > [Espacenet - patent search](#)

[Espacenet - patent search](#)

[Global Patent Index \(GPI\)](#)

[Release notes](#)

[European Publication Server](#)

[Searching Asian documents](#)

[EP full-text search](#)

## Espacenet patent search



Print



Share



### Support

Talk to EPO experts or get help from other users

> [Visit the discussion forum](#)

## Espacenet - patent search

Global Patent Index (GPI)

Release notes

European Publication Server

Searching Asian documents

EP full-text search

# Espacenet patent search

 Print  Share



With its worldwide coverage and search features, Espacenet offers free access to information about inventions and technical developments from 1782 to today.

[Open Espacenet](#)

› [Open classic Espacenet](#)

› [National patent offices' databases](#)

## Support

Talk to EPO experts or get help from other users

› [Visit the discussion forum](#)

## Contact

› [Contact us](#)

## Training

› [Visit our e-learning centre for all tutorials and recorded seminars](#)

› [Upcoming Patent](#)

Espacenet is accessible to beginners and experts and is updated daily. It contains

Let's have overview understandings on Espacenet briefly.

How to use New Espacenet (2 min+)

First, we can learn basic operation and make practices of Espacenet.

Smart Search Basic Mode (3 min)



# Title of invention: “Glass coating having super repellent performance to the windshield of an automobile”

## Background of the invention;

Wipers are installed on the windows of automobiles to remove rain and ensure visibility. A normal wiper is mechanical, and a rubber member is attached to the part that comes into contact with the glass surface, and this member slides on the glass surface in an arc, demonstrating the effect of ensuring visibility immediately after sliding. This mechanism is a technical means that has been adopted for many years and is still adopted even today when science and technology have developed, but the mechanical device itself is complicated and it is necessary to replace the rubber member regularly. In some cases, it may not always be possible to secure sufficient visibility in the event of heavy rain, and the adoption of new technological means is desired.

If the wiper machinery can be completely removed by the new invention, it can promote the modern progress of automobile technology and greatly contribute to the expansion of profits in the automobile industry.

## Technical features of this invention;

The purpose of the this invention is to secure the visibility of the windshield in rainy weather by applying a glass coating having super repellent performance to the windshield of an automobile. As a result, all the conventional wiper type mechanical devices can be removed. As this super repellent glass coating, a hybrid coating agent having both the water repellency of silicon and the durability of fluorine is used. According to this invention, it is possible to obtain a windshield exhibiting excellent water repellency. Even if it rains, the water droplets form spherical polka dots and flow down the glass surface, so there is no water film that blocks the view. Since the polka dots are blown off by the wind pressure while driving, a clear view can be secured.



Filing date of invention:

December 31, 2022

Search keywords, just for your reference

Car, Automobile

Windshield, Front glass, Window

Silicon water repellency, Repellency

Fluorine-based durability, Durability



Europäisches Patentamt  
European Patent Office  
Office européen des brevets

**Espacenet**  
Patent search

Enter your search terms



Office/Language ▼

Search

[My Espacenet](#)

[Help](#)

[Classification search](#)

[Results](#)



[Advanced search](#)

[Feedback](#)

## Espacenet: free access to over 140 million patent documents





All text fields or names =

Group

automobile

All text fields or names =

Search

Reset

### 128 results found

List view

List content

Sort by

Text only

All

Relevance

(0 patents selected) Select the first 20 results

1. CLEANING METHOD FOR AUTOMOBILE GLASS

JPH10167025A • 1998-06-23 • NICHIBOO TEC KK

Earliest priority: 1996-12-05 • Earliest publication: 1998-06-23

PROBLEM TO BE SOLVED: To provide a cleaning method for an automobile glass which can remove scale, oil film, acid rain spot, the mark of salt water, the mark of water drop after washing and wiper injury stuck on the automobile glass perfectly

2. WINDOW SHIELD SYSTEM FOR AUTOMOBILE

JP3196401B2 (A) • 2001-08-06 • NISSAN MOTOR

Earliest priority: 1993-03-11 • Earliest publication: 1994-09-20

MS Pゴシック 11 A A

**B** *I* U [Grid] [Color] [Text Color] [Bulleted List] [Numbered List] [Decrease Indent] [Increase Indent] [Align Center]

標準 [Dropdown] 条件付き書式 [Dropdown] 挿入 [Dropdown] 削除 [Dropdown] 書式 [Dropdown]

Σ [Dropdown] [Dropdown] 並べ替えと検索とフィルター [Dropdown] 検索と選択 [Dropdown]

貼り付け クリップボード フォント 配置 数値 スタイル セル 編集

A1 [Dropdown] [X] [Check] [fx] No

No	Title	Inventors	Applicants	Publication number	Earliest priority	IPC	CP
1	CLEANING METHOD FOR AUTOMOBILE GLASS	YAMAMOTO KATSUYUKI	NICHIBOO TEC KK	<a href="#">JPH10167025A</a>	1996-12-05	B08B1/00 B08B3/02 B60S3/04 B08B1/00 B08B3/02 B60S3/04	
2	WINDOW SHIELD SYSTEM FOR AUTOMOBILE	KAMIMURA RYUZO	NISSAN MOTOR	<a href="#">JP3196401B2</a> <a href="#">JPH06262943A</a>	1993-03-11	B60J1/00 C03C17/42 B60S1/02 B60S1/38 C09K3/18 B60J1/00 B60S1/02 B60S1/38 C03C17/42 C09K3/18	C03
3	GLASS SYSTEM	NAKAI AKIHIRO	NAKAI KOMUTEN KK	<a href="#">JP2008207750A</a>	2007-02-28	B60J1/00 B60S1/02 B60S1/38	A47 B60 B60



Query language: en de fr ▾

AND ▾ + Field

AND ▾ + Field ×

Title ▾ all ▾ → Group

Title or abstract ▾ all ▾ → Group

OR ▾ + Field ×

Publication number ▾ any ▾ → Group

Application number ▾ any ▾ → Group

Priority number ▾ any ▾ → Group

Publication date ▾ = ▾ → Group

Advanced search  
Various search items can be defined.



1



2



## Espacenet search result - 20230507\_1759

128 results found for automobile window rain glass coating wiper high pressure air repellent

Results 1 to 20 displayed

Query language: en / de / fr

Sort by: Relevance



## Searching

### Smart search field identifiers and Advanced search fields

Smart search and Advanced search have been synchronised. The table below lists the field identifiers that you can use in **Smart search** and their equivalents in **Advanced search**.

Field identifier in Smart search		Description / Equivalent search criterion in Advanced search	Example
in new Espacenet	in classic Espacenet		
nftxt	-	All text fields or names	nftxt="extreme uv lithography"
ntxt	<i>txt</i>	Title, abstract or names	ntxt=microscope lens
ti	<i>ti</i>	Title	ti="mouse trap"
ab	<i>ab</i>	Abstract	ab="mouse trap"
desc	<i>desc</i>	Description	desc=lens
claims	<i>claims</i>	Claims	claims=laser
ta	<i>ta</i>	Title or abstract	ta="laser printer"
ctxt	-	Title, abstract or claims	ctxt=milking ctxt=robots
ftxt	<i>extftxt</i>	All text fields (title, abstract, description or claims)	ftxt=nanoparticles
in	<i>in</i>	Inventors	in=smith
pa	<i>pa</i>	Applicants	pa=siemens
ia	<i>ia</i>	Inventors or applicants	ia=apple OR ia="ries klaus"
pd <sup>1</sup>	<i>pd</i>	Publication date	pd=20180107
pr	<i>pr</i>	Priority number	pr=ep20050104792
pn	<i>pn</i>	Publication number	pn=ep1000000 pn=EPB1 <sup>2</sup>
ap	<i>ap</i>	Application number	ap=jp19890234567

ipc	<i>ipc</i>	IPC	ipc=A63B49/08
cpc	<i>cpc</i>	CPC	cpc="A61K31/13"
cpcc	<i>cpcc</i>	CPC C-sets	cpcc="C08F297/02"
cl	<i>cl</i>	IPC or CPC	cl=C10J3
ct	<i>ct</i>	Cited documents	ct=ep1000000

<sup>1</sup> You can search by the publication date of the earliest publication (e.g. EPA1) of a patent document but not by the publication dates of subsequent publications (e.g. EPB1). This is because subsequent publication dates are not indexed for search purposes.

<sup>2</sup> You can search by kind code, using the following type of query: pn=<CC><KC>.

Keyword search is usually done with "Keyword in title or abstract". Keyword search in title or abstract picks up keywords that appear in the title and abstract of the invention, so it doesn't contain much noise.

A full-text search of the specification will find hits if there is at least one keyword, so you can get more search results. However, you have to be prepared that there is a lot of noise compared to searching by Title, Abstract, and Claims.

\* no omissions in the search, effective narrowing down is possible, and there is little noise.



## Operators

Operator	Example in Smart search	Description
<b>Boolean operators</b> <sup>3</sup>	AND pa=bosch AND pa=siemens	will retrieve documents where both <b>Bosch</b> and <b>Siemens</b> are applicants
	OR in=smith OR in=huber	will retrieve documents where the inventor's name is <b>Smith</b> or <b>Huber</b>
	NOT txt=laser NOT semiconductor	will retrieve documents containing laser, while excluding documents containing <b>semiconductor</b>
<b>Proximity operators</b>	prox/distance<nr mouse trap	will retrieve documents where mouse and trap are fewer than three words apart, independently of the order in which mouse and trap appear
	prox/distance<nr/ ordered mouse prox/distance<3/ordered trap	will retrieve documents where mouse and trap occur in that order and are fewer than three words apart
	prox/ordered mouse prox/ordered trap	will retrieve documents where mouse appears before trap
	prox/unit=sentence mouse prox/unit=sentence trap	will retrieve, in the first example, documents where mouse and trap occur in the same sentence
	cpc=(C08F220/38 prox/unit=sentence (EP)) cpcc=(C08F218/08 prox/unit=sentence (C08F220/06, US, EP))	will retrieve, in the second example, documents with the classification symbol <b>C08F220/38</b> assigned by <b>EP</b> will retrieve, in the third example, documents with the C-sets <b>C08F218/08</b> and <b>C08F220/06</b> assigned by <b>US</b> and <b>EP</b>
prox/unit=paragraph mouse prox/unit=paragraph trap	will retrieve documents where mouse and trap occur in the same paragraph	

You can enter a search expression using Boolean operators such as AND, OR, NOT, ( ), and truncation.

Search example;

(“herpes simplex” or HSV) and (gene or recombin\* or mutant or mutat\*) and (nervous or cancer)

Comparison operators	Example	Description
all <sup>4</sup>	ti all "paint brush head"	will retrieve documents containing all words entered within quotes but not necessarily in the order in which the words appear
any <sup>5</sup>	ti any "motor engine"	will retrieve documents containing any of the words entered within quotes
=	pa=siemens pa = "siemens ag"	will retrieve documents where either Siemens or Siemens AG are applicants
>	pd > 1998	will retrieve documents having a publication date after 1998
>=	pd >= 1998	will retrieve documents having a publication date in or after 1998
<	pd < 1998	will retrieve documents having a publication date before 1998
<=	pd <= 2018	will retrieve documents having a publication date in or before 2018
within	pd within "1998 2018" pd within "1998, 2018"	will retrieve documents published between 19980101 and 20181231. <sup>6</sup>

<sup>3</sup> The default operator in Smart search is "AND". Boolean operators have precedence from left to right.

<sup>4</sup> This will give the same results as ti=paint AND ti=brush AND ti=head.

<sup>5</sup> This will give the same results as ti=motor OR ti=engine.

<sup>6</sup> This will give the same results as pd >=1998 AND pd <=2018.

## Nested queries

Parentheses can be used to specify the order in which the search terms<sup>7</sup> and operators should be interpreted. Information within parentheses is read first, and information outside parentheses is read next.

Example: (mouse OR rat) AND trap

If there are nested parentheses, the search engine processes the innermost parenthetical expression first, then the next, and so on, until the entire query has been interpreted.

Example: ((mouse OR rat) AND trap) OR mousetrap

<sup>7</sup> A search term is a word, classification symbol, assigning office, date or patent number.

## Searching by date

**Date formats:** You can search by publication date in **Smart search** and **Advanced search** using any of the following formats:

Format	Example	Format	Example
yyyy	2019	yyyymmdd	20190305
yyyymm	201903	yyyy-mm-dd	2019-03-05
yyyy-mm	2019-03	dd/mm/yyyy	05/03/2019
mm/yyyy	03/2019	dd.mm.yyyy	05.03.2019
mm.yyyy	03.2019		

**Date ranges:** The following range formats are admissible for publication date range searches, using any of the allowed date formats:

Format in Smart search	Format in Advanced search, Publication date	Example in Smart search	Example in Advanced search
<Date1>:<Date2>	<Date1>:<Date2>	1998:2018	1998:2018
"<Date1>:<Date2>"	<Date1>:<Date2>	"01.1998:12.2018"	01.1998:12.2018
pd within "<Date1>:<Date2>"	<Date1>:<Date2>	pd within "1998:2018"	1998:2018
pd="<Date1>:<Date2>"	<Date1>:<Date2>	pd="199801:201812"	199801:201812
pd within <Date1>,<Date2>	<Date1>,<Date2>	pd within 1998,2018	1998,2018
pd=<Date1>,<Date2>	<Date1>,<Date2>	pd=1998-01,2018-12	1998-01,2018-12
pd within <Date1> <Date2>	<Date1> <Date2>	pd within "1998 2018"	1998 2018
pd=<Date1> <Date2>	<Date1> <Date2>	pd="01/1998 12/2018"	01/1998 12/2018

## Truncation

When creating search formulas for Smart Search and Advanced Search, various truncations (prefix match, left match) that support plural forms and inflections can be used to expand the search range.

(Search example)mutation: 9620 → mutat\*: 19815

## Truncations

Truncation symbols (wildcards) available in **Smart search** and **Advanced search**:

Wildcard	Description	Examples
*	stands for a string of characters of any length	car* will retrieve car, cars, card, cart, care, carbon, etc.
?	stands for no characters or one character	car? will retrieve car, card, cart, care, etc., but <u>not</u> cards, carbon
#	stands for exactly one character	car# will retrieve card, cart, care, cars, etc., but <u>not</u> car, cards

## Restrictions

- Left truncation (?car) is not supported.
- If two alphanumeric characters precede a ? or # symbol (co? or pa#), then a maximum of three truncation symbols is allowed (ca??? will retrieve call, cart, card, care, cable, etc.).
- If three or more alphanumeric characters precede a ? or # symbol, then a maximum of seven truncation symbols is allowed.
- There must be at least three alphanumeric characters preceding a \* symbol.
- Wildcards cannot be used when searching by IPC and/or CPC. The data is auto-posted up to classification group level. This means that all sub-levels will also be searched at the same time. At sub-group level, please use /low in combination with the "=" operator. If you search by **B65D81/24/low**, the system will, for example, also search for results classified as B65D81/26.

We can utilize advanced functions; Boolean Operators, Truncations, etc.

Full Potential of Smart Search (7 min)

Let's use Template for Advanced Search!

Advanced Search Predefined Template (5 min)

We have to download the results for further analysis and its utilization.

How to download the results list (5 min+)

# First, get familiar with keyword searches!

Note:

In the English database, it is searched by word unit.

For example, vehicle and vehicles are treated as different words.

Therefore, it is necessary to use “?” to represent any single character and “\*” to represent any character string as wildcards to prevent omissions in searches.

If it is difficult to prevent search omissions with keywords alone, it is necessary to use patent classifications IPC and CPC to prevent omissions in searches.

In this patent search contest, we would like you to **try keyword search first**. For those who have mastered keyword searches, we recommend searching using patent classifications.

For this contest, some people will be searching for patents for the first time, and also the time is limited, so keyword searches are fine without using patent classifications.

I would like you to learn patent classification for future development. Because, searching using patent classification has the effect of compensating for the shortcomings of keyword searching.

<Advantages and disadvantages of searches using patent classifications>

Merit;

There is not much need to consider synonyms, etc.

There are few search omissions and noise.

Inventions that are difficult to express in words can also be searched using classification concepts.

It is possible to search using superordinate concepts and subordinate concepts.

Demerit;

Correct understanding of each classification item is required.

In some new technical fields, patent classification has not yet been developed.

Choosing the right patent classification is not easy.

# International Patent Classification (IPC)

A universal patent classification that is operated under international agreements.

The Internet version of the IPC is the officially published IPC and is available on the WIPO IPC website. (<https://www.wipo.int/classifications/ipc/>).

Currently in 8th edition. Classified into over 70,000 items. Amended from time to time.

The IPC presents the entire body of knowledge recognized as relevant to the patent field, divided into eight sections. Sections are the highest level of the IPC hierarchy.

The eight sections and their titles are as follows.

- A; Daily Necessities
- B; Processing Operations; Transportation
- C; Chemistry; Metallurgy
- D; Textile; Paper
- E; Fixed structure
- F; Mechanical Engineering; Lighting; Heating; Weapons; Blasting
- G; Physics
- H; Electricity

# Hierarchy principle

The IPC divides the entire technical body of knowledge using a hierarchy:

**Sections, Classes, Subclasses, Groups and Subgroups**, in descending order of hierarchy.

The hierarchical structure is shown in the example below.

Section: H Electrical

Class: H01 Basic electrical elements

Subclass: H01F Magnet

Main Group: H01F 1/00 Magnets or magnetic bodies featuring magnetic materials

Subgroup: 1/01 • inorganic materials

Subgroup: 1/03 • • characterized by holding power

Subgroup: 1/032 • • • Hard magnetic materials

Subgroup: 1/04 • • • • metals or alloys

Subgroup: 1/047 • • • • • Alloys Characterized by Composition

Subgroup: 1/053 • • • • • • Containing rare earth elements

# Hierarchy of IPC (visual)

*Example; A47B3/083*

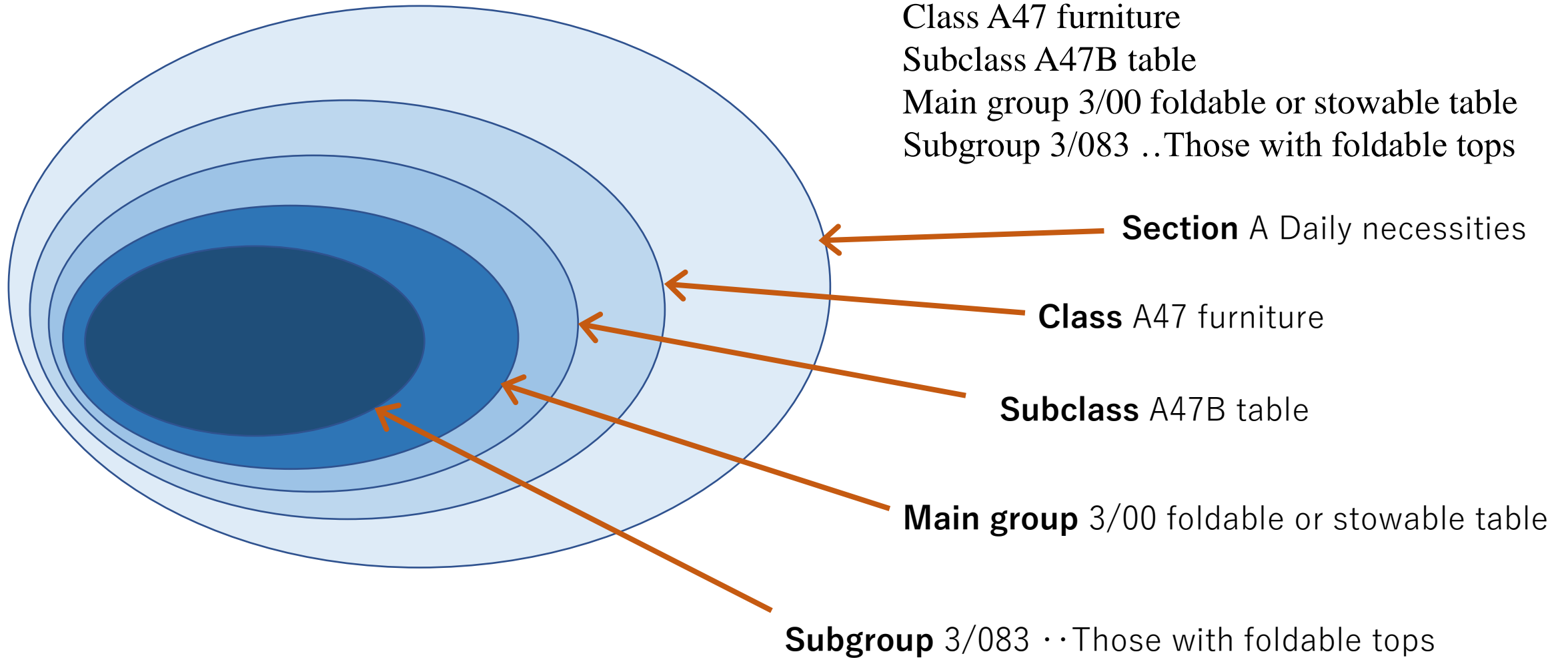
Section A Daily necessities

Class A47 furniture

Subclass A47B table

Main group 3/00 foldable or stowable table

Subgroup 3/083 ..Those with foldable tops





# There are two ways to find the desired international patent classification.

The first method is to access the **International Patent Classification Table**, perform a keyword search of the classification table, and find the appropriate classification from the results. <https://www.wipo.int/classifications/ipc/>

However, when using this method, it is necessary to be familiar with the system of classification tables, terminology, and concept development.

The second method is to **first perform a keyword search** in the Patent Search System, **select patent publications that match the target technology** from the search results, and **examine the classification given to the patent publications**. It is an easy-to-use method for beginners who are not familiar with the classification table.

Cooperative Patent Classification(CPC)

<https://www.cooperativepatentclassification.org/home>



(19) **United States**  
(12) **Patent Application Publication** (10) **Pub. No.:** US 2022/0045842 A1  
**Shi** (43) **Pub. Date:** Feb. 10, 2022

(54) **SECURE BLOCKCHAIN INTEGRATED CIRCUIT**  
(71) Applicant: **Alexander Yuan Shi**, San Diego, CA (US)  
(72) Inventor: **Alexander Yuan Shi**, San Diego, CA (US)  
(21) Appl. No.: **17/307,933**  
(22) Filed: **May 4, 2021**

#### Related U.S. Application Data

(63) Continuation of application No. 16/322,099, filed on Jan. 30, 2019, now Pat. No. 10,999,059, filed as application No. PCT/US2019/015735 on Jan. 29, 2019.  
(60) Provisional application No. 62/634,744, filed on Feb. 23, 2018, provisional application No. 62/623,422, filed on Jan. 29, 2018, provisional application No. 62/675,049, filed on May 22, 2018.

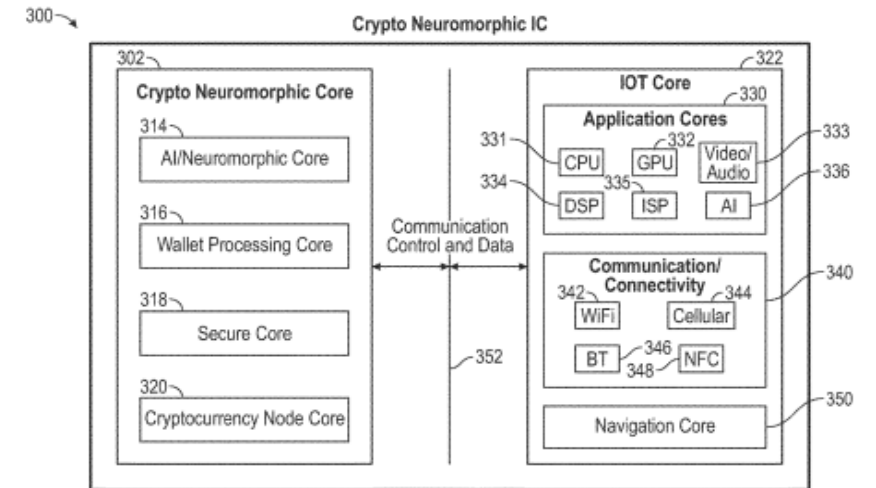
#### Publication Classification

(51) **Int. Cl.**  
**H04L 9/06** (2006.01)  
**G06Q 20/36** (2006.01)  
**G06Q 20/38** (2006.01)

**G06Q 20/40** (2006.01)  
**H04L 9/08** (2006.01)  
**H04L 9/32** (2006.01)  
(52) **U.S. CL.**  
**CPC** ..... **H04L 9/06** (2013.01); **G06Q 20/3674** (2013.01); **G06Q 20/389** (2013.01); **G06N 20/00** (2019.01); **H04L 9/0819** (2013.01); **H04L 9/3213** (2013.01); **G06Q 20/401** (2013.01)

#### (57) ABSTRACT

An integrated circuit comprising a CPU coupled to a system bus, a network interface configured to interface with an external device, and a crypto neuromorphic core coupled to the system bus. The cryptographic core comprising a processor or core, an internal bus, and a non-transitory computer-readable memory, wherein the crypto neuromorphic core is isolated from the CPU and the network interface via the system bus and the crypto neuromorphic core runs its own operating system. The crypto neuromorphic core is configured to: contain a secure core comprising a secure processor and dedicated/protected memory; store a private key in the dedicated/protected memory accessible to the secure core but not accessible to other components of the crypto neuromorphic core, the central processing unit, and the network interface; add data to a blockchain using the private key via the network interface; and read data from the blockchain via the network interface.



Try to make your exercise until  
you get accustomed to use patent  
database.

**Practice!!!**

# Attachment 14

## Thinkings by IPOs on the future policy, strategy, etc. regarding patent information Data Base and its Development

	ID	SG	TH	MY	BN	LA	MM	PH	VN	RH
Please describe about the <b>future policy of IPO</b> regarding the database construction (including data update, continuation, development, problems to be solved, etc.).	Every day, DGIP will update, solving problem and develop <a href="https://pdki-indonesia.dgip.go.id/">https://pdki-indonesia.dgip.go.id/</a>	For internal use, we intend to enhance data warehouse for better and more accurate retrieval of statistic reports to develop future products.	The DIP has developed the Data Warehouse, which aims at linking all industrial property (invention patent, design patent, layout-design of integrate circuit, trademark, trade secret and geographical indication), and copyright database.	Amendments to the Patent Act, Regulations and Directives 2021 are being drafted. The amendment will involve changes to the specifications, scope and working process of the system. The data cleaning process is done continuously and on demand. Preparing data extraction for data exchange with the external organization; WIPO, JPO, EPO, EUIPO and CNIPO.	No answer	(As we are now using a WIPO IPAS which is quite powerful and sustainability, we shall update and fix the problems as appropriate and keep the system always up to date to serve our works going smoothly)	As because of still trying to implement condition, we don't have any specific answer for this question. Regarding the database construction, Trademark database will be established firstly in Myanmar.	IPOPHL patent database shall always be in accordance with WIPO data standards to efficiently implement WIPO IPAS and WIPO Publish.	We focus on improving the database including: completeness, quick updating, accessibility to the public, the ability and many features of a search engine. Policies are being developed, so we will share when available.	We are now developing our own website platform which link to patent database in which anyone can access to patent information.
Please describe regarding your <b>financial plan</b> to build and update the database (open to users for free, government funding, or charge external users, etc.).	Government funding.	IP2SG users are free to access the published patent data. Bulk data purchase is available.	The IP Advisory Center (IPAC), an IP consulting unit under the DIP, provides commercial patent database services to the public, including Patbase and PatSnap. Each year, we allocate budgets to purchase various commercial patent databases, which are accessible by the public free of charge. We receive government funding to manage and operate the database yearly.	Provide data for free access (Amendment of the Patent Act, Regulations and Directives 2021).	No answer	Now we are try to make a database more friendly with users as much as possible by updating the information on IP Portal where the users can access to the information. In there, we have added many Link to many websites and Databases for users to facilitate accessibility more easier. We have quite limited funding for develop a system and database but we are try our best to make it useful.	According to current status in Myanmar, we could not give any certain answer for this question.	The IPOPHL is very intent on building and updating its database which is open for public use. However, with regards to financial plans or budget allocation, IPOPHL is cautious on these since IPOPHL does not receive any financial assistance from the Philippine government.	Financial plans are being developed so we will share when available.	No answer
Please describe about the status of <b>human resource development</b> such as education and training for patent information search engineers (current status, future policy, etc.).	DGIP conduct training to all engineer to improve their technical ability to develop better applications.	No answer	Currently, the Patent Search System demonstrates only the data about bibliographic data, publication data, and patent specification, but doesn't include the status of human resource development such as education and training, yet.	Training on patent search and examination to increase in efficiency and quality of IP examination for patent examiners.	Not applicable as BruIPO do not conduct patent search.	(Now we are under a preparation to establish Technology and Innovation Support Center to help interested person to access to patent information provided by WIPO, in this project will including a Training for a person in charge to help people to access a system in current situation and some training for future joining of those sectors who wish to join)	In fact, we have future policy for the development of human resource and we are starting some recruitment in our IP Department at currently. At the beginning state, we have very few human resources and participated in the establishment of IP System in Myanmar. Those human resources had to participate in the training by the different international organization in some IP courses. For new recruitment, they will be trained by senior office staffs firstly base on their education. But, human resource is still limited to be fulfilled for our IP Department at currently.	As far as the Examiners of the Bureau of Patents are concerned, there is no need to develop additional human resources for patent information retrieval. But it would be beneficial for existing examiners to undergo periodic seminars to be updated on how they can maximize the usage of the available specialized databases and apply/use the information/techniques that they retrieved/learned in actual examination work, i.e., in determining the patentability of the patent application and in coming up with the substantive patent examination report.	Future policy, financial plans and human resource are being developed so we will share when available.	All new staffs will be trained on the search for patent information as well as the areas which related to IP. Moreover, we also have dissemination workshop and seminar on patent information searching for IP agents, university faculties and other related stakeholders as well.
Please describe on the <b>problems that the IPO has</b> regarding patent information retrieval.	Our challenge is that the contents of patent documents are many and complex, and there are special characters that make it difficult to accurately search for patents.	Retrieval of patent specification in machine readable format from image-based documents is not accurate because of limitations in OCR technology.	We are working to improve our electronic submission system called "e-Filing" to address data incompleteness, especially specification data that is currently stored in image file.	Current system has limitation on the number of searches results up to 2000 records only. This constraint has resulted in inaccurate search results.	This is not applicable to BruIPO as search and substantive examination is outsourced to foreign IP office. BruIPO only uses external database platform such WIPO Patentscope and ASEAN Patentscope to retrieve bibliographic information and specification for PCT National Phase application entering Brunei.	(Lack of knowledges and skills to access to databases, in this case many officers do not know how to access)	We have still lack of practice to give the answer of this question.	It is costly and as mentioned above, IPOPHL does not receive any financial assistance from the Philippine government. IPOPHL also has off-site storage for (old) patent documents. A system is in place for the retrieval and return of such documents. Some of these old documents have already been scanned/digitized and uploaded into the patent database, but there are some which still need to be digitized. There are also a few documents that have been damaged due to floodwaters.	Regarding the retrieval of patent information, patent data is saved in many other formats such as images, text files, word, ... and the deep and complete search takes a lot of time.	There are some problems: -Limited information from some foreign IPO database platform. -Some patents filing in the office cannot be found in any other patent database.
Describe what IPO knows about the <b>user's problems</b> with patent information retrieval.	i. Searching result still not accurate 100%. ii. Delay one day for Patent application status.	Users have provided feedback on the requirement for a function to export search results.	Patent information can be overwhelming. Sometimes users do not know which retrieved information is relevant or useful for them. Long processing time to retrieve information is another difficulty faced by users. The search function is support only for Thai language.	The dissemination of Malaysian Patent Publication (full specification) is in line with the Patents (Amendment) Act 2021 which is still ongoing. Currently, a fee needs to be paid in order to get patent full specification. No full text search on specification data	Keyword based search may result in invalid outcome as it requires special operators to detect and match with relevant patent documents	(Do not know how to access to databases, lack of information about available database in the world)	We don't have certain answer.	Some users experience slow processing of information Lack of advanced search option	Today, users have the advantage of accession to many patent databases. Domestic database are WIPO Publish, IPLib..., and international ones as Google Patents, EPO Patent Search, ... But there are also difficulties when the volume of data is very large on and the skill of searching patent information.	Some possible problems: -The source of database (website for searching patent information) -The users' limit knowledge of language. -The users' awareness of the patent information and the familiarity with patent information retrieval system. -The users' awareness of content of the patent. -The users' understanding of the patent information since it is sometimes too technical to understand by common users.

# Attachment 15

## Responses from universities in Cambodia regarding the questionnaires Q4-Q58

Questionnaires		Total 187 universities	ID (32)	TH (6)	MY (6)	BN (25)	LA (29)	MM (20)	PH (30)	VN (21)	KH (18)
Q4	I have used a patent information retrieval system.	3.7	4.3	4.7	3.8	3.3	2.8	2.8	4.2	4.4	3.2
Q5	It is easy for me to access the database and search for patent information.	3.7	3.9	4.2	3.8	3.7	3.2	3.0	4.0	4.0	3.7
Q6	The development of a <b>patent information retrieval system is important</b> for strengthening the competitiveness of universities.	4.4	4.4	4.3	4.7	4.3	4.1	4.6	4.8	4.4	4.4
Q7	The patent information retrieval system needs to <b>be available on the Internet</b> .	4.6	4.6	4.3	4.7	4.7	4.1	4.5	4.9	4.6	4.8
Q8	Domestic patent information retrieval systems need to <b>be available in English</b> in addition to the local language.	4.4	4.3	4.8	4.7	4.5	3.9	4.4	4.8	4.5	4.4
Q9	The patent information retrieval system needs to <b>be free and easy to use</b> .	4.4	4.6	4.8	4.8	4.5	3.8	4.2	4.7	4.1	4.4
Q10	The Intellectual Property Office must take <b>leadership</b> in building a patent information retrieval system.	4.4	4.5	4.3	4.7	4.2	3.9	4.2	4.8	4.5	4.6
Q11	Utilization of commercial databases is not available due to the high cost.	3.7	3.2	3.8	4.2	3.8	3.3	3.5	4.3	3.8	3.8
Q12	Patent information is <b>important for promoting research</b> and development at universities.	4.5	4.5	4.0	4.7	4.5	4.2	4.6	4.9	4.4	4.7
Q13	Patent information is not so important in promoting research and development at universities.	2.0	2.0	2.7	1.8	1.9	2.4	1.4	1.8	2.4	2.4
Q14	Patent information is <b>useful for science and technology research</b> conducted at universities.	4.6	4.4	5.0	4.7	4.6	4.3	4.6	4.9	4.4	4.7
Q15	Patent information is <b>useful for setting research themes</b> for university science and technology research.	4.4	4.3	4.5	4.7	4.4	4.1	4.2	4.8	4.3	4.5
Q16	Patent information helps us find themes for <b>collaborative research with companies</b> .	4.3	4.4	3.8	4.7	4.4	4.0	3.8	4.6	4.2	4.4
Q17	Patent information is <b>useful for basic research</b> at universities.	4.1	4.0	4.5	4.5	4.1	3.9	3.8	4.6	3.9	4.4
Q18	Patent information is <b>important for commercial research</b> in universities.	4.4	4.2	4.5	4.3	4.5	4.2	4.0	4.8	4.3	4.4
Q19	Patent information is <b>useful when universities collaborate with companies</b> .	4.3	4.3	4.5	4.5	4.5	4.2	4.1	4.7	4.1	4.4
Q20	Universities have applied for patents on the results of joint research with companies.	3.7	3.9	4.7	4.2	3.3	3.3	3.5	4.0	3.7	3.9
Q21	Patent information is <b>useful for grasping the technological development status of companies</b> in the research and development area of universities.	4.2	4.1	4.5	4.5	4.4	3.8	3.9	4.7	4.4	4.1
Q22	<b>Corporate patent information</b> is useful for advancing research and development at universities.	4.3	4.2	4.3	4.7	4.3	4.1	4.0	4.7	4.2	4.1
Q23	The technology described in the patent information of a company can be a <b>hint for research and development</b> at a university.	4.1	4.3	4.3	4.3	4.2	3.8	3.7	4.6	3.8	4.3
Q24	Analyzing corporate patent information helps <b>prevent duplication</b> of research and development at universities.	4.3	4.3	4.8	4.7	4.5	4.0	3.8	4.8	4.3	4.6
Q25	Regarding the results of research and development conducted by the university, we are constantly considering whether or not to apply for a patent.	3.7	3.6	4.0	3.8	3.2	3.3	3.8	4.0	4.0	4.0
Q26	Our university has applied for a patent for our research and development results.	3.6	4.1	4.3	4.3	2.8	2.9	3.1	4.3	3.6	3.3
Q27	When filing a patent application, patent information is searched to <b>evaluate novelty and inventive step</b> .	4.2	4.2	3.8	4.7	4.3	3.5	3.6	4.8	4.4	4.4
Q28	We have analyzed patent information and used it to formulate R & D strategies at universities.	3.6	3.7	4.2	3.8	2.9	3.3	3.3	4.0	3.8	4.0
Q29	Analysis of patent information is useful for <b>forecasting product demand and market</b> .	4.1	4.0	4.7	4.3	4.2	3.6	3.9	4.4	4.2	4.2
Q30	Analyzing patent information is important to <b>win the competition with companies</b> in the research and development area of universities.	4.0	4.0	4.8	4.7	3.8	3.9	3.8	4.4	3.8	3.8
Q31	Our university has the experience of obtaining patent rights for university technology.	3.4	3.8	4.3	4.0	2.8	3.0	2.6	4.0	3.5	2.8
Q32	Our university has exercised rights against companies based on our patent rights.	3.1	3.3	3.3	3.7	2.6	3.1	2.6	3.5	3.5	2.8
Q33	We have searched for patent information when exercising patent rights.	3.6	3.6	3.8	4.2	3.2	3.4	3.3	4.0	4.1	3.6

Q34	We have used patent information in negotiations with businesses in contracts between universities and businesses.	3.3	3.5	3.3	3.7	2.8	3.1	3.0	3.6	3.9	3.2
Q35	Our university has been warned of patent infringement based on the patent rights held by the company.	2.6	2.8	3.7	3.0	2.4	2.7	2.5	1.8	3.3	2.7
Q36	It is important to search for patent information in order to <b>invalidate the patent rights</b> held by others.	3.9	3.7	4.5	4.5	3.9	3.9	3.9	4.0	4.0	3.9
Q37	Our university has been licensed for patent rights owned by companies.	2.9	3.1	3.7	3.7	2.4	3.0	2.5	2.6	3.1	2.9
Q38	Our university has licensed the patent rights owned by our university to a company.	3.2	3.5	4.3	4.5	2.6	3.0	2.4	3.4	3.7	3.3
Q39	Patent information is useful when <b>selecting a license partner</b> company.	4.0	3.9	4.5	4.2	3.9	3.9	3.6	4.3	4.2	4.1
Q40	Our university routinely monitors the patent information of companies in the research and development area of the university.	3.2	3.5	3.8	3.0	2.5	3.1	2.4	3.3	3.5	3.6
Q41	Our university laboratories make full use of patent information.	3.1	3.2	3.3	3.3	2.2	3.0	2.8	3.5	3.2	3.4
Q42	Our university utilizes an online system when searching for patent information.	3.6	3.8	4.3	4.0	3.2	3.2	2.9	4.1	4.0	3.8
Q43	At our university, patent information is searched using paper-based publications.	3.0	2.9	3.5	3.2	2.6	3.4	2.7	2.8	3.0	3.0
Q44	Patent information retrieval <b>should be free of charge</b> using the Internet.	4.4	4.3	4.7	4.5	4.6	4.2	4.2	4.6	4.0	4.3
Q45	The patent information search is performed in the library of the Intellectual Property Office.	3.5	4.0	3.5	3.8	2.8	4.0	3.0	2.8	3.6	3.8
Q46	Our university has staff specializing in patent information retrieval.	3.2	3.5	3.3	3.3	2.6	2.9	2.6	4.1	3.1	3.1
Q47	At our university, we are developing human resources for patent information retrieval.	3.3	3.5	3.5	3.8	2.6	2.9	3.4	3.6	3.1	3.6
Q48	Our university uses an external institution to search for patent information.	3.0	2.8	3.5	3.5	2.6	3.1	2.9	2.9	3.0	3.4
Q49	Research on the <b>valuation of patent rights</b> requires analysis of patent information.	4.2	4.1	4.3	4.2	4.4	4.0	4.1	4.3	4.4	4.1
Q50	In order to promote <b>industry-academia collaboration</b> , it is necessary to analyze patent information.	4.3	4.3	4.2	4.3	4.4	4.3	3.9	4.4	4.0	4.2
Q51	In the <b>IOT field</b> , patent information retrieval and utilization are important.	4.2	4.1	4.7	4.3	4.2	4.1	4.0	4.4	4.3	4.3
Q52	In the <b>AI field</b> , patent information retrieval and utilization are important.	4.3	4.1	4.7	4.5	4.2	4.3	4.0	4.6	4.3	4.5
Q53	We hope that the <b>Intellectual Property Office</b> will actively carry out education, training, and dissemination activities for patent information	4.5	4.5	4.8	4.8	4.7	4.3	3.9	4.8	4.3	4.8
Q54	Utilization of patent information retrieval system is important for <b>innovation creation</b> in our country.	4.5	4.4	4.7	4.7	4.5	4.5	4.3	4.8	4.4	4.8
Q55	Utilization of patent information retrieval system will lead to <b>increase of patent applications</b> by universities and companies in our country.	4.5	4.3	4.8	4.3	4.6	4.4	4.3	4.7	4.1	4.6
Q56	Utilization of the patent information retrieval system is important for <b>improving the ranking of universities</b> .	4.2	4.1	4.5	3.8	4.3	4.4	4.2	4.6	3.6	4.4
Q57	Utilization of patent information retrieval system is <b>important for corporate growth</b> .	4.4	4.3	4.5	4.2	4.4	4.3	4.0	4.8	4.2	4.5
Q58	Utilization of patent information retrieval system <b>contributes to the development of industry</b> .	4.5	4.3	4.3	4.3	4.6	4.4	4.1	4.9	4.4	4.6



# Attachment 17

## Linear Regression for University results

Model Summary - Q54

Model	R	R <sup>2</sup>	Adjusted R <sup>2</sup>	RMSE
1	0	0	0	0.641
2	0.638	0.407	0.404	0.495
3	0.718	0.515	0.51	0.449
4	0.746	0.556	0.549	0.431
5	0.759	0.576	0.567	0.422
6	0.767	0.589	0.578	0.417

Coefficients

Model		Unstandardized	Standard Error	Standardized	t	p
1	(Intercept)	4.535	0.047		96.679	< .001
2	(Intercept)	1.887	0.238		7.936	< .001
	Q53	0.586	0.052	0.638	11.262	< .001
3	(Intercept)	1.198	0.241		4.968	< .001
	Q53	0.44	0.052	0.479	8.412	< .001
	Q52	0.311	0.049	0.365	6.402	< .001
4	(Intercept)	0.635	0.269		2.366	0.019
	Q53	0.415	0.051	0.451	8.195	< .001
	Q52	0.254	0.049	0.297	5.21	< .001
	Q15	0.211	0.051	0.219	4.119	< .001
5	(Intercept)	0.857	0.273		3.133	0.002
	Q53	0.407	0.05	0.444	8.209	< .001
	Q52	0.254	0.048	0.298	5.327	< .001
	Q15	0.202	0.05	0.21	4.013	< .001
	Q13	-0.073	0.025	-0.143	-2.955	0.004
6	(Intercept)	1.002	0.277		3.617	< .001
	Q53	0.423	0.049	0.46	8.551	< .001
	Q52	0.255	0.047	0.299	5.406	< .001
	Q15	0.215	0.05	0.223	4.299	< .001
	Q13	-0.067	0.025	-0.132	-2.732	0.007
	Q11	-0.078	0.033	-0.115	-2.357	0.019

*Note.* The following covariates were considered but not included: Q4, Q5, Q6, Q7, Q8, Q9, Q10, Q12, Q14, Q16, Q17, Q18, Q19, Q20, Q21, Q22, Q23, Q24, Q25, Q26, Q27, Q28, Q29, Q30, Q31, Q32, Q33, Q34, Q35, Q36, Q37, Q38, Q39, Q40, Q41, Q42, Q43, Q44, Q45, Q46, Q47, Q48, Q49, Q50, Q51.

Model Summary - Q55

Model	R	R <sup>2</sup>	Adjusted R <sup>2</sup>	RMSE
1	0	0	0	0.72

2	0.592	0.351	0.347	0.582
3	0.657	0.431	0.425	0.546
4	0.688	0.473	0.464	0.527
5	0.715	0.511	0.5	0.509
6	0.73	0.532	0.519	0.499
7	0.739	0.546	0.531	0.493

Coefficients

Model		Unstandardized	Standard Error	Standardized	t	p
1	(Intercept)	4.46	0.053		84.694	< .001
2	(Intercept)	1.7	0.279		6.086	< .001
	Q53	0.611	0.061	0.592	9.998	< .001
3	(Intercept)	0.463	0.357		1.295	0.197
	Q53	0.532	0.059	0.515	8.949	< .001
	Q14	0.35	0.069	0.294	5.099	< .001
4	(Intercept)	0.032	0.363		0.089	0.929
	Q53	0.482	0.059	0.468	8.209	< .001
	Q14	0.302	0.067	0.253	4.479	< .001
	Q44	0.2	0.052	0.216	3.816	< .001
5	(Intercept)	-0.171	0.355		-0.481	0.631
	Q53	0.4	0.061	0.388	6.576	< .001
	Q14	0.232	0.068	0.195	3.427	< .001
	Q44	0.191	0.051	0.206	3.762	< .001
	Q52	0.215	0.058	0.225	3.735	< .001
6	(Intercept)	-0.264	0.349		-0.755	0.451
	Q53	0.361	0.061	0.35	5.895	< .001
	Q14	0.16	0.071	0.134	2.249	0.026
	Q44	0.173	0.05	0.188	3.461	< .001
	Q52	0.22	0.057	0.23	3.9	< .001
	Q24	0.151	0.052	0.17	2.889	0.004
7	(Intercept)	-0.163	0.348		-0.468	0.64
	Q53	0.396	0.062	0.384	6.36	< .001
	Q14	0.169	0.07	0.142	2.409	0.017
	Q44	0.165	0.05	0.178	3.321	0.001
	Q52	0.22	0.056	0.229	3.933	< .001
	Q24	0.162	0.052	0.183	3.135	0.002
	Q5	-0.085	0.036	-0.126	-2.363	0.019

*Note.* The following covariates were considered but not included: Q4, Q6, Q7, Q8, Q9, Q10, Q11, Q12, Q13, Q15, Q16, Q17, Q18, Q19, Q20, Q21, Q22, Q23, Q25, Q26, Q27, Q28, Q29, Q30, Q31, Q32, Q33, Q34, Q35, Q36, Q37, Q38, Q39, Q40, Q41, Q42, Q43, Q45, Q46, Q47, Q48, Q49, Q50, Q51.



Model	R	R <sup>2</sup>	Adjusted R <sup>2</sup>	RMSE
1	0	0	0	0.778
2	0.436	0.19	0.185	0.702
3	0.51	0.26	0.252	0.673
4	0.557	0.31	0.298	0.652
5	0.584	0.341	0.326	0.638
6	0.597	0.356	0.338	0.633

Coefficients

Model		Unstandardized	Standard Error	Standardized	t	p
1	(Intercept)	4.225	0.057		74.26	< .001
2	(Intercept)	2.55	0.26		9.823	< .001
	Q29	0.409	0.062	0.436	6.583	< .001
3	(Intercept)	1.741	0.315		5.524	< .001
	Q29	0.339	0.062	0.361	5.471	< .001
	Q17	0.266	0.064	0.276	4.181	< .001
4	(Intercept)	2.063	0.318		6.49	< .001
	Q29	0.37	0.061	0.394	6.106	< .001
	Q17	0.256	0.062	0.265	4.15	< .001
	Q35	-0.155	0.043	-0.225	-3.627	< .001
5	(Intercept)	1.593	0.35		4.551	< .001
	Q29	0.305	0.063	0.325	4.814	< .001
	Q17	0.218	0.062	0.226	3.529	< .001
	Q35	-0.153	0.042	-0.221	-3.631	< .001
	Q52	0.204	0.07	0.198	2.939	0.004
6	(Intercept)	1.471	0.352		4.18	< .001
	Q29	0.301	0.063	0.321	4.798	< .001
	Q17	0.198	0.062	0.205	3.189	0.002
	Q35	-0.176	0.043	-0.254	-4.072	< .001
	Q52	0.198	0.069	0.191	2.869	0.005
	Q45	0.089	0.043	0.13	2.055	0.041

*Note.* The following covariates were considered but not included: Q4, Q5, Q6, Q7, Q8, Q9, Q10, Q11, Q12, Q13, Q14, Q15, Q16, Q18, Q19, Q20, Q21, Q22, Q23, Q24, Q25, Q26, Q27, Q28, Q30, Q31, Q32, Q33, Q34, Q36, Q37, Q38, Q39, Q40, Q41, Q42, Q43, Q44, Q46, Q47, Q48, Q49, Q50, Q51, Q53.

Model Summary - Q57

Model	R	R <sup>2</sup>	Adjusted R <sup>2</sup>	RMSE
1	0	0	0	0.766
2	0.536	0.287	0.284	0.648
3	0.613	0.375	0.368	0.608
4	0.633	0.401	0.391	0.597
5	0.647	0.419	0.406	0.59

6	0.662	0.438	0.423	0.582
7	0.673	0.452	0.434	0.576
8	0.682	0.466	0.445	0.57

Coefficients

Model		Unstandardized	Standard Error	Standardized	t	p
1	(Intercept)	4.358	0.056		77.856	< .001
2	(Intercept)	1.882	0.291		6.479	< .001
	Q18	0.567	0.066	0.536	8.638	< .001
3	(Intercept)	1.033	0.32		3.232	0.001
	Q18	0.438	0.067	0.414	6.577	< .001
	Q52	0.326	0.064	0.32	5.084	< .001
4	(Intercept)	0.638	0.344		1.852	0.066
	Q18	0.349	0.073	0.33	4.792	< .001
	Q52	0.307	0.063	0.301	4.838	< .001
	Q21	0.206	0.074	0.185	2.796	0.006
5	(Intercept)	0.309	0.367		0.841	0.401
	Q18	0.316	0.073	0.299	4.315	< .001
	Q52	0.254	0.066	0.25	3.833	< .001
	Q21	0.189	0.073	0.17	2.589	0.01
	Q53	0.171	0.071	0.156	2.394	0.018
6	(Intercept)	0.559	0.376		1.488	0.139
	Q18	0.346	0.073	0.327	4.724	< .001
	Q52	0.254	0.065	0.249	3.881	< .001
	Q21	0.217	0.073	0.195	2.968	0.003
	Q53	0.209	0.072	0.191	2.901	0.004
	Q8	-0.15	0.061	-0.154	-2.481	0.014
7	(Intercept)	0.368	0.382		0.962	0.337
	Q18	0.336	0.073	0.318	4.639	< .001
	Q52	0.237	0.065	0.232	3.631	< .001
	Q21	0.215	0.072	0.193	2.98	0.003
	Q53	0.213	0.071	0.194	2.982	0.003
	Q8	-0.145	0.06	-0.148	-2.413	0.017
	Q40	0.085	0.039	0.121	2.167	0.032
8	(Intercept)	0.511	0.385		1.328	0.186
	Q18	0.339	0.072	0.321	4.719	< .001
	Q52	0.248	0.065	0.243	3.823	< .001
	Q21	0.214	0.072	0.192	2.987	0.003
	Q53	0.203	0.071	0.185	2.859	0.005
	Q8	-0.143	0.059	-0.146	-2.407	0.017
	Q40	0.108	0.04	0.154	2.676	0.008
	Q48	-0.078	0.037	-0.12	-2.091	0.038

*Note.* The following covariates were considered but not included: Q4, Q5, Q6, Q7, Q9, Q10, Q11, Q12, Q13, Q14, Q15, Q16, Q17, Q19, Q20, Q22, Q23, Q24, Q25, Q26, Q27, Q28, Q29, Q30, Q31, Q32, Q33, Q34, Q35, Q36, Q37, Q38, Q39, Q41, Q42, Q43, Q44, Q45, Q46, Q47, Q49, Q50, Q51.

Model Summary - Q58

Model	R	R <sup>2</sup>	Adjusted R <sup>2</sup>	RMSE
1	0	0	0	0.666
2	0.578	0.335	0.331	0.545
3	0.664	0.441	0.435	0.501
4	0.695	0.483	0.474	0.483
5	0.712	0.507	0.496	0.473
6	0.724	0.524	0.511	0.466
7	0.732	0.535	0.52	0.461
8	0.741	0.549	0.532	0.456
9	0.748	0.56	0.54	0.452

Coefficients

Model		Unstandardized	Standard Error	Standardized	t	p
1	(Intercept)	4.465	0.049		91.671	< .001
2	(Intercept)	2.141	0.244		8.763	< .001
	Q18	0.532	0.055	0.578	9.645	< .001
3	(Intercept)	1.155	0.28		4.127	< .001
	Q18	0.411	0.055	0.447	7.517	< .001
	Q53	0.335	0.057	0.351	5.911	< .001
4	(Intercept)	0.836	0.282		2.961	0.003
	Q18	0.356	0.055	0.387	6.521	< .001
	Q53	0.259	0.058	0.272	4.454	< .001
	Q52	0.209	0.054	0.236	3.854	< .001
5	(Intercept)	0.535	0.294		1.82	0.07
	Q18	0.284	0.059	0.309	4.849	< .001
	Q53	0.243	0.057	0.254	4.241	< .001
	Q52	0.197	0.053	0.223	3.712	< .001
	Q21	0.175	0.059	0.18	2.98	0.003
6	(Intercept)	0.869	0.318		2.732	0.007
	Q18	0.322	0.06	0.35	5.398	< .001
	Q53	0.243	0.056	0.255	4.311	< .001
	Q52	0.224	0.053	0.252	4.187	< .001
	Q21	0.219	0.06	0.226	3.627	< .001
	Q14	-0.175	0.069	-0.159	-2.549	0.012
7	(Intercept)	0.998	0.321		3.111	0.002
	Q18	0.338	0.06	0.367	5.671	< .001
	Q53	0.269	0.057	0.282	4.705	< .001

	Q52	0.22	0.053	0.248	4.158	< .001
	Q21	0.232	0.06	0.239	3.86	< .001
	Q14	-0.153	0.069	-0.139	-2.224	0.027
	Q8	-0.103	0.049	-0.121	-2.114	0.036
8	(Intercept)	1.316	0.344		3.819	< .001
	Q18	0.349	0.059	0.379	5.913	< .001
	Q53	0.271	0.056	0.284	4.803	< .001
	Q52	0.225	0.052	0.254	4.301	< .001
	Q21	0.232	0.059	0.239	3.91	< .001
	Q14	-0.183	0.069	-0.167	-2.655	0.009
	Q8	-0.131	0.049	-0.153	-2.64	0.009
	Q13	-0.066	0.028	-0.125	-2.35	0.02
9	(Intercept)	1.277	0.342		3.733	< .001
	Q18	0.334	0.059	0.363	5.659	< .001
	Q53	0.262	0.056	0.275	4.674	< .001
	Q52	0.214	0.052	0.241	4.104	< .001
	Q21	0.213	0.06	0.22	3.573	< .001
	Q14	-0.183	0.068	-0.167	-2.678	0.008
	Q8	-0.144	0.049	-0.169	-2.917	0.004
	Q13	-0.076	0.028	-0.144	-2.69	0.008
	Q39	0.089	0.043	0.115	2.059	0.041

*Note.* The following covariates were considered but not included: Q4, Q5, Q6, Q7, Q9, Q10, Q11, Q12, Q15, Q16, Q17, Q19, Q20, Q22, Q23, Q24, Q25, Q26, Q27, Q28, Q29, Q30, Q31, Q32, Q33, Q34, Q35, Q36, Q37, Q38, Q40, Q41, Q42, Q43, Q44, Q45, Q46, Q47, Q48, Q49, Q50, Q51.

## Responses from companies in Cambodia regarding the questionnaires Q4-Q46

Questionnaires		Total 41 companies	ID(1)	TH(27)	MY(5)	BN(1)	PH(3)	VN(4)
Q4	I have used a patent information retrieval system.	4.0	5.0	4.3	4.2	1.0	4.0	3.8
Q5	It is easy for me to access the database and search for patent information.	3.6	4.0	3.7	4.6	2.0	4.3	3.5
Q6	The development of a patent information retrieval system is <b>important for strengthening the competitiveness of companies</b> .	4.5	5.0	4.7	4.4	3.0	4.7	4.3
Q7	The patent information retrieval system needs to <b>be available on the Internet</b> .	4.5	4.0	4.6	5.0	3.0	4.7	4.5
Q8	Domestic patent information retrieval systems need to <b>be available in English</b> in addition to the local language.	4.6	5.0	4.6	4.8	5.0	4.0	4.5
Q9	The patent information retrieval system needs to <b>be available free of charge</b> .	4.5	5.0	4.6	4.2	4.0	5.0	4.3
Q10	The <b>Intellectual Property Office</b> must take <b>leadership in building a patent information retrieval system</b> .	4.2	5.0	4.3	4.4	4.0	4.7	4.0
Q11	Utilization of commercial databases is not available due to the high cost.	3.6	4.0	3.6	3.8	3.0	4.0	3.5
Q12	Patent information is <b>important in promoting our business</b> .	4.3	4.0	4.5	4.4	4.0	4.3	4.0
Q13	Patent information is not so important in promoting our business.	2.2	2.0	1.9	2.4	3.0	2.0	2.8
Q14	Patent information is useful for <b>grasping the technological development</b> status of other companies in our business area.	4.3	4.0	4.4	4.6	4.0	4.3	4.3
Q15	The patent information of other companies is <b>useful for advancing our research and development</b> .	4.4	4.0	4.6	4.8	3.0	4.7	4.0
Q16	The technology described in the patent information of other companies can <b>be a hint for our research and development</b> .	4.2	4.0	4.5	4.8	3.0	4.3	3.8
Q17	Analyzing the patent information of other companies helps <b>prevent duplication of R &amp; D activities</b> .	4.3	4.0	4.4	4.8	5.0	5.0	4.3
Q18	We are constantly considering whether or not we should apply for a patent for the results of our research and development.	3.6	4.0	3.9	4.0	4.0	4.0	3.8
Q19	Our company has applied for a patent for our research and development results.	3.1	4.0	4.0	3.0	1.0	2.0	3.3
Q20	When filing a patent application, patent information is searched to <b>evaluate novelty and inventive step</b> .	4.2	5.0	4.4	4.8	4.0	4.3	4.0
Q21	Our company has analyzed patent information and used it to formulate our business strategy.	3.5	4.0	3.8	3.0	3.0	3.7	3.8
Q22	Analysis of patent information is useful for <b>forecasting product demand and market</b> .	3.9	4.0	4.1	4.6	4.0	3.7	4.3
Q23	Analyzing patent information is important to <b>win the competition with competitors in our business domain</b> .	4.1	5.0	4.2	4.6	4.0	4.0	3.8
Q24	Our company has the experience of obtaining patent rights for our technology.	3.3	3.0	4.1	2.6	3.0	2.7	3.5
Q25	Our company has exercised its rights against other companies based on the patent rights acquired by our company.	3.0	3.0	3.4	2.6	2.0	2.0	3.3
Q26	Our company has searched for patent information when exercising patent rights.	3.3	3.0	3.9	2.8	3.0	2.7	3.8
Q27	Our company has used patent information when negotiating with partner companies in M & A and business-to-business contracts.	3.1	3.0	3.8	2.8	2.0	2.7	3.5
Q28	Our company has been warned of infringement of patent rights on our products based on the patent rights held by other companies.	2.7	3.0	2.9	2.0	1.0	1.7	3.3
Q29	When selling our products, we try to check for infringement of patents of other companies to get FTO (Freedom to Operate Search).	3.5	4.0	4.0	2.8	3.0	3.3	3.3
Q30	In order to <b>invalidate the patent rights</b> held by other companies, it is necessary to search for patent information.	4.1	4.0	4.4	4.0	5.0	4.0	3.8
Q31	Our company has been licensed for patent rights owned by other companies.	2.8	3.0	3.2	2.8	2.0	3.0	3.3
Q32	Patent information is useful when <b>selecting a license partner company</b> .	4.1	5.0	4.1	4.8	3.0	4.3	3.8
Q33	Our company routinely monitors the patent information of other companies in our business area.	3.4	3.0	3.8	2.8	3.0	3.3	3.3
Q34	Our company has fully utilized patent information.	3.4	3.0	3.9	3.0	2.0	2.7	3.5
Q35	Our company uses an online system to search for patent information.	3.9	3.0	4.4	3.2	3.0	4.0	3.5
Q36	Our company searches for patent information using paper-based publications.	2.5	3.0	2.3	2.0	3.0	2.3	3.3
Q37	Patent information retrieval should <b>be free of charge using the Internet</b> .	4.1	5.0	4.4	4.0	4.0	4.7	3.8
Q38	The patent information search is performed in the library of the Intellectual Property Office.	2.7	5.0	2.9	2.6	3.0	2.7	3.5
Q39	We have employees who specialize in patent information retrieval.	3.5	3.0	4.2	3.0	1.0	3.0	3.3
Q40	Our company is developing human resources for patent information retrieval.	3.2	2.0	3.5	3.0	3.0	4.0	3.3
Q41	Our company uses an external organization to search for patent information.	2.8	2.0	2.7	2.6	3.0	3.7	3.8
Q42	We hope that the <b>Intellectual Property Office</b> will actively carry out <b>education, training, and dissemination activities</b> for patent information retrieval.	4.4	5.0	4.5	4.8	4.0	4.7	4.3
Q43	Utilization of patent information retrieval system is <b>important for innovation creation</b> in our country.	4.6	4.0	4.7	4.8	5.0	5.0	4.3
Q44	Utilization of patent information retrieval system will lead to <b>increase of patent applications</b> by companies in our country.	4.3	4.0	4.5	4.8	4.0	4.7	4.0
Q45	Utilization of patent information retrieval system is <b>important for corporate growth</b> .	4.2	4.0	4.4	4.8	4.0	4.3	4.0
Q46	Utilization of patent information retrieval system <b>contributes to the development of industry</b> .	4.4	4.0	4.4	4.8	4.0	5.0	4.3



## Attachment 20

### Linear Regressions for company results

#### Model Summary - Q43

Model	R	R <sup>2</sup>	Adjusted R <sup>2</sup>	RMSE
1	0	0	0	0.58
2	0.87	0.757	0.75	0.29
3	0.889	0.79	0.779	0.273
4	0.909	0.827	0.812	0.251
5	0.921	0.849	0.831	0.238
6	0.932	0.868	0.848	0.226

#### Coefficients

Model		Unstandardized	Standard Error	Standardized	t	p
1	(Intercept)	4.65	0.092		50.743	< .001
2	(Intercept)	1.289	0.312		4.128	< .001
	Q17	0.743	0.068	0.87	10.876	< .001
3	(Intercept)	0.775	0.363		2.132	0.04
	Q17	0.683	0.069	0.8	9.898	< .001
	Q12	0.178	0.074	0.195	2.413	0.021
4	(Intercept)	0.726	0.335		2.167	0.037
	Q17	0.752	0.068	0.881	11.005	< .001
	Q12	0.226	0.07	0.248	3.228	0.003
	Q5	-0.126	0.046	-0.222	-2.756	0.009
5	(Intercept)	0.736	0.318		2.317	0.026
	Q17	0.644	0.081	0.754	7.977	< .001
	Q12	0.209	0.067	0.229	3.121	0.004
	Q5	-0.143	0.044	-0.251	-3.247	0.003
	Q20	0.141	0.062	0.212	2.253	0.031
6	(Intercept)	0.978	0.32		3.054	0.004
	Q17	0.612	0.078	0.717	7.872	< .001
	Q12	0.215	0.063	0.235	3.382	0.002
	Q5	-0.138	0.042	-0.242	-3.29	0.002
	Q20	0.149	0.059	0.224	2.508	0.017
	Q36	-0.076	0.034	-0.141	-2.225	0.033

*Note.* The following covariates were considered but not included: Q4, Q6, Q7, Q8, Q9, Q10, Q11, Q13, Q14, Q15, Q16, Q18, Q19, Q21, Q22, Q23, Q24, Q25, Q26, Q27, Q28, Q29, Q30, Q31, Q32, Q33, Q34, Q35, Q37, Q38, Q39, Q40, Q41, Q42.

#### Model Summary - Q44

Model	R	R <sup>2</sup>	Adjusted R <sup>2</sup>	RMSE
-------	---	----------------	-------------------------	------

1	0	0	0	0.677
2	0.618	0.382	0.366	0.54
3	0.684	0.467	0.439	0.508

Coefficients

Model		Unstandardized	Standard Error	Standardized	t	p
1	(Intercept)	4.45	0.107		41.543	< .001
2	(Intercept)	1.523	0.61		2.496	0.017
	Q15	0.654	0.135	0.618	4.845	< .001
3	(Intercept)	1.117	0.598		1.868	0.07
	Q15	0.486	0.144	0.459	3.365	0.002
	Q32	0.277	0.114	0.333	2.437	0.02

*Note.* The following covariates were considered but not included: Q4, Q5, Q6, Q7, Q8, Q9, Q10, Q11, Q12, Q13, Q14, Q16, Q17, Q18, Q19, Q20, Q21, Q22, Q23, Q24, Q25, Q26, Q27, Q28, Q29, Q30, Q31, Q33, Q34, Q35, Q36, Q37, Q38, Q39, Q40, Q41, Q42.

Model Summary - Q45

Model	R	R <sup>2</sup>	Adjusted R <sup>2</sup>	RMSE
1	0	0	0	0.838
2	0.692	0.479	0.465	0.613
3	0.774	0.599	0.578	0.545
4	0.827	0.685	0.658	0.49
5	0.869	0.755	0.727	0.438
6	0.887	0.787	0.756	0.414
7	0.908	0.824	0.792	0.382
8	0.922	0.85	0.817	0.359
9	0.934	0.872	0.84	0.336

Coefficients

Model		Unstandardized	Standard Error	Standardized	t	p
1	(Intercept)	4.375	0.132		33.027	< .001
2	(Intercept)	1.399	0.513		2.725	0.01
	Q32	0.713	0.121	0.692	5.905	< .001
3	(Intercept)	0.942	0.476		1.98	0.055
	Q32	0.6	0.112	0.582	5.339	< .001
	Q24	0.247	0.074	0.364	3.338	0.002
4	(Intercept)	1.187	0.435		2.728	0.01
	Q32	0.63	0.102	0.612	6.206	< .001
	Q24	0.347	0.074	0.511	4.698	< .001
	Q25	-0.23	0.074	-0.332	-3.126	0.003
5	(Intercept)	0.485	0.448		1.081	0.287
	Q32	0.532	0.096	0.516	5.535	< .001



	Q24	0.309	0.067	0.456	4.613	< .001
	Q25	-0.272	0.067	-0.393	-4.047	< .001
	Q22	0.335	0.106	0.307	3.156	0.003
6	(Intercept)	0.673	0.431		1.561	0.128
	Q32	0.547	0.091	0.531	6.014	< .001
	Q24	0.409	0.077	0.603	5.322	< .001
	Q25	-0.22	0.068	-0.317	-3.257	0.003
	Q22	0.32	0.1	0.294	3.186	0.003
	Q39	-0.194	0.085	-0.265	-2.29	0.028
7	(Intercept)	0.683	0.399		1.713	0.096
	Q32	0.512	0.085	0.497	6.015	< .001
	Q24	0.359	0.074	0.53	4.882	< .001
	Q25	-0.23	0.063	-0.332	-3.676	< .001
	Q22	0.305	0.093	0.28	3.286	0.002
	Q39	-0.223	0.079	-0.304	-2.813	0.008
	Q40	0.152	0.058	0.233	2.606	0.014
8	(Intercept)	0.869	0.382		2.271	0.03
	Q32	0.465	0.082	0.451	5.648	< .001
	Q24	0.349	0.069	0.514	5.044	< .001
	Q25	-0.189	0.061	-0.273	-3.09	0.004
	Q22	0.343	0.089	0.315	3.867	< .001
	Q39	-0.251	0.075	-0.343	-3.334	0.002
	Q40	0.213	0.061	0.326	3.515	0.001
	Q41	-0.12	0.051	-0.195	-2.344	0.025
9	(Intercept)	0.181	0.461		0.392	0.698
	Q32	0.418	0.08	0.405	5.249	< .001
	Q24	0.362	0.065	0.533	5.57	< .001
	Q25	-0.233	0.06	-0.336	-3.869	< .001
	Q22	0.336	0.083	0.309	4.057	< .001
	Q39	-0.236	0.071	-0.321	-3.331	0.002
	Q40	0.237	0.058	0.362	4.113	< .001
	Q41	-0.136	0.048	-0.22	-2.812	0.008
	Q8	0.2	0.085	0.17	2.361	0.025

*Note.* The following covariates were considered but not included: Q4, Q5, Q6, Q7, Q9, Q10, Q11, Q12, Q13, Q14, Q15, Q16, Q17, Q18, Q19, Q20, Q21, Q23, Q26, Q27, Q28, Q29, Q30, Q31, Q33, Q34, Q35, Q36, Q37, Q38, Q42.

#### Model Summary - Q46

Model	R	R <sup>2</sup>	Adjusted R <sup>2</sup>	RMSE
1	0	0	0	0.714
2	0.466	0.217	0.197	0.64
3	0.575	0.331	0.295	0.6

4	0.645	0.417	0.368	0.568
5	0.694	0.482	0.423	0.543
6	0.742	0.551	0.485	0.513

Coefficients

Model		Unstandardized	Standard Error	Standardized	t	p
1	(Intercept)	4.45	0.113		39.4	< .001
2	(Intercept)	2.763	0.529		5.224	< .001
	Q20	0.381	0.117	0.466	3.249	0.002
3	(Intercept)	3.151	0.519		6.069	< .001
	Q20	0.418	0.111	0.512	3.771	< .001
	Q38	-0.184	0.073	-0.34	-2.506	0.017
4	(Intercept)	2.987	0.497		6.015	< .001
	Q20	0.4	0.105	0.489	3.797	< .001
	Q38	-0.267	0.078	-0.494	-3.411	0.002
	Q41	0.175	0.076	0.333	2.299	0.027
5	(Intercept)	3.275	0.494		6.628	< .001
	Q20	0.496	0.111	0.606	4.484	< .001
	Q38	-0.259	0.075	-0.478	-3.447	0.001
	Q41	0.218	0.076	0.414	2.878	0.007
	Q21	-0.233	0.111	-0.3	-2.097	0.043
6	(Intercept)	3.174	0.469		6.771	< .001
	Q20	0.472	0.105	0.577	4.497	< .001
	Q38	-0.219	0.073	-0.404	-2.998	0.005
	Q41	0.149	0.077	0.283	1.926	0.062
	Q21	-0.329	0.113	-0.422	-2.907	0.006
	Q40	0.184	0.08	0.33	2.293	0.028

*Note.* The following covariates were considered but not included: Q4, Q5, Q6, Q7, Q8, Q9, Q10, Q11, Q12, Q13, Q14, Q15, Q16, Q17, Q18, Q19, Q22, Q23, Q24, Q25, Q26, Q27, Q28, Q29, Q30, Q31, Q32, Q33, Q34, Q35, Q36, Q37, Q39, Q42.

Responses from IP Law Firm/Agent in Cambodia regarding the questionnaires Q4-Q27

Questionnaires		Total48 LawFirm	ID (3)	SG (4)	TH (2)	MY (13)	LA (3)	PH (9)	VN (11)	KH (3)
Q4	It is useful to search for patent information in advance <b>when acting on behalf of a patent application.</b>	4.6	4.7	3.8	5.0	4.8	5.0	4.6	4.4	5.0
Q5	If <b>requested by the client</b> of the patent application, we will search for the patent application.	4.4	5.0	4.3	5.0	4.6	4.3	4.8	4.2	3.0
Q6	It is useful for the IP law firm/agent to utilize the prior art information disclosed in the issued patent information <b>when drafting the specification</b> of the patent application.	4.5	4.7	5.0	5.0	4.7	4.0	4.4	4.2	4.7
Q7	We constantly monitor the patent information of the client's business area.	3.5	3.3	2.5	3.5	3.8	4.3	3.3	3.5	3.7
Q8	We <b>support</b> the client by searching and analyzing patent information in the <b>client's business area.</b>	4.0	4.3	3.5	5.0	4.4	4.3	3.4	4.0	3.0
Q9	<b>When applying for invalidation</b> of another company's patent at the request of the client, we will search for patent information.	4.3	4.7	2.8	5.0	4.8	4.3	4.8	4.0	2.7
Q10	When applying for invalidation of another company's patent, we utilize an external organization to search for patent information.	3.4	3.7	4.0	2.5	3.3	4.3	3.2	3.3	3.3
Q11	<b>When a client receives a warning of patent infringement</b> from another company, it is important to search for patent information as a countermeasure.	4.6	4.3	4.5	5.0	4.8	4.3	5.0	4.4	4.3
Q12	If the <b>client is sued by another company for patent infringement</b> , it is important to search for patent information.	4.7	4.3	4.8	5.0	4.8	4.0	5.0	4.5	4.7
Q13	Patent information retrieval <b>helps the client's business.</b>	4.5	4.3	4.5	5.0	4.7	5.0	4.7	4.1	4.3
Q14	<b>Patent information retrieval engineers</b> should be trained within IP-related law firm/agent.	4.1	4.7	2.5	4.0	4.4	3.7	4.1	4.0	4.7
Q15	Patent information retrieval is the <b>scope of business of IP-related law firm/agent.</b>	4.1	4.0	3.5	4.0	4.3	4.7	4.1	4.0	3.3
Q16	Patent information retrieval is not the scope of the business of IP-related law firm/agent.	2.4	2.7	2.3	2.5	2.4	3.3	1.8	2.5	3.0
Q17	Patent information retrieval should <b>be free of charge using the Internet.</b>	4.1	4.7	4.3	4.0	4.1	4.7	3.4	4.5	4.3
Q18	<b>Education, training and dissemination activities</b> for patent information retrieval should be carried out more actively.	4.6	4.3	3.8	4.7	4.8	5.0	4.8	4.5	5.0
Q19	We have analyzed patent information and used it to formulate our business strategy.	3.8	4.0	3.5	4.7	4.0	4.3	3.4	4.1	2.3
Q20	Analysis of patent information is <b>useful for forecasting product demand and market.</b>	4.1	4.3	3.8	4.3	4.5	3.7	3.9	4.1	4.3
Q21	Analyzing patent information is important to win the competition with competitors in the client company's business domain.	4.0	4.3	3.5	4.3	4.5	4.3	3.9	3.8	2.7
Q22	It is important for the IP law firm/agent to have the <b>ability to search patent information</b> and to analyze and utilize the patent information in order to improve the <b>satisfaction of the client.</b>	4.6	4.0	4.5	5.0	4.9	4.0	4.7	4.5	5.0
Q23	We hope that the <b>Intellectual Property Office</b> will actively carry out <b>education, training, and dissemination activities</b> for patent information retrieval.	4.6	4.3	3.5	5.0	4.9	4.3	4.9	4.5	4.7
Q24	Utilization of patent information retrieval system is <b>important for innovation creation</b> in our country.	4.5	4.0	4.3	4.3	4.8	4.3	4.9	4.3	4.7
Q25	Utilization of patent information retrieval system will lead to <b>increase of patent applications</b> by universities/companies in our country.	4.3	3.7	3.0	4.7	4.8	3.7	4.6	4.4	4.7
Q26	Utilization of patent information retrieval system is <b>important for companies' growth.</b>	4.2	4.0	3.5	4.7	4.7	4.3	4.2	3.8	4.7
Q27	Utilization of patent information retrieval system <b>contributes to the development of industry.</b>	4.6	4.3	4.0	4.7	4.8	4.0	4.6	4.7	4.7



# Attachment 23

## Linear Regression for IP Law Firm/Agent results

Model Summary - Q24

Model	R	R <sup>2</sup>	Adjusted R <sup>2</sup>	RMSE
1	0	0	0	0.651
2	0.712	0.507	0.497	0.462
3	0.755	0.57	0.55	0.436
4	0.781	0.611	0.584	0.42
5	0.814	0.663	0.632	0.395
6	0.833	0.695	0.658	0.381
7	0.852	0.725	0.685	0.365

Coefficients

Model		Unstandardized	Standard Error	Standardized	t	p
1	(Intercept)	4.542	0.094		48.337	< .001
2	(Intercept)	1.041	0.513		2.029	0.048
	Q23	0.76	0.11	0.712	6.885	< .001
3	(Intercept)	0.344	0.557		0.618	0.54
	Q23	0.7	0.107	0.656	6.539	< .001
	Q6	0.216	0.085	0.255	2.547	0.014
4	(Intercept)	0.706	0.561		1.257	0.215
	Q23	0.812	0.115	0.761	7.039	< .001
	Q6	0.27	0.085	0.319	3.165	0.003
	Q4	-0.245	0.114	-0.243	-2.153	0.037
5	(Intercept)	0.497	0.534		0.93	0.357
	Q23	0.63	0.13	0.59	4.86	< .001
	Q6	0.241	0.081	0.285	2.972	0.005
	Q4	-0.285	0.108	-0.283	-2.635	0.012
	Q18	0.296	0.115	0.308	2.585	0.013
6	(Intercept)	-0.025	0.572		-0.043	0.966
	Q23	0.574	0.128	0.538	4.501	< .001
	Q6	0.197	0.081	0.234	2.448	0.019
	Q4	-0.297	0.104	-0.296	-2.853	0.007
	Q18	0.32	0.111	0.333	2.886	0.006
	Q13	0.203	0.098	0.193	2.085	0.043
7	(Intercept)	0.221	0.561		0.394	0.696
	Q23	0.539	0.124	0.505	4.363	< .001
	Q6	0.179	0.078	0.212	2.296	0.027
	Q4	-0.279	0.101	-0.277	-2.773	0.008
	Q18	0.35	0.108	0.364	3.259	0.002
	Q13	0.245	0.096	0.233	2.561	0.014



Q13	0.33	0.146	0.254	2.262	0.029
Q15	0.195	0.09	0.225	2.162	0.036
Q20	0.237	0.11	0.25	2.16	0.036

*Note.* The following covariates were considered but not included: Q4, Q5, Q6, Q7, Q8, Q9, Q10, Q11, Q12, Q14, Q16, Q17, Q19, Q21, Q22, Q23.

Model Summary - Q27

Model	R	R <sup>2</sup>	Adjusted R <sup>2</sup>	RMSE
1	0	0	0	0.616
2	0.436	0.19	0.172	0.56

Coefficients

Model		Unstandardized	Standard Error	Standardized	t	p
1	(Intercept)	4.563	0.089		51.346	< .001
2	(Intercept)	2.538	0.622		4.079	< .001
	Q23	0.44	0.134	0.436	3.283	0.002

*Note.* The following covariates were considered but not included: Q4, Q5, Q6, Q7, Q8, Q9, Q10, Q11, Q12, Q13, Q14, Q15, Q16, Q17, Q18, Q19, Q20, Q21, Q22.

# Overviews of Patent Information Workshop and Invention Business Contest

Yoshitoshi Tanaka

ERIA WG Leader

Professor Emeritus, Tokyo Institute of Technology



# Overview of Patent Search Workshop and Invention Business Contest

**Countries;** Basically, All ASEAN countries (except: Myanmar, Singapore)

**Participants;** Professors, Researchers, Practitioners, Companies, IPO officials, etc.

## **Workshop;**

- “Importance of patent information for local inventions and industrial development”
- “How to use PatentScope, Espacenet, etc.”
- “Practical demonstration and exercises of Espacenet, PatentScope, etc.”

## **Invention Business Contest;**

- Practical understandings on patent information searching through practical experiences
- Motivation up for patent information Searching through hands-on training

## **Organization for workshop and competition;**

- Working group is responsible for preparing patent search manual
- Coordination and facilitation of workshop and competition

\*Joint working with ERIA and local IP Office \*Local IP Office’s leadership is expected.

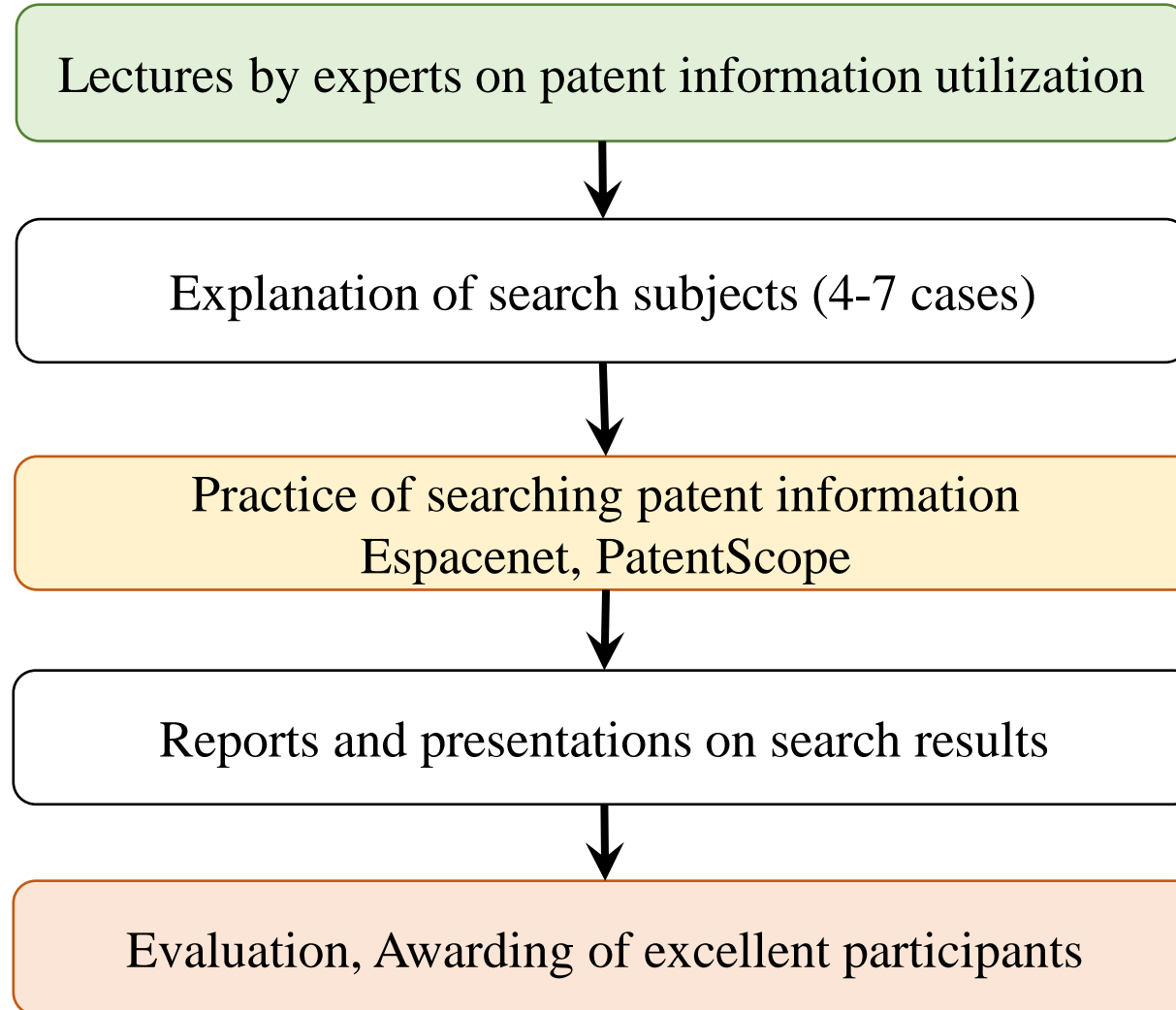
# Basic Flow of Workshop and Invention Business Contest

## Workshop

Acquisition of knowledge related to patent information utilization

## Invention Business Contest

Dissemination and Enlightenment of Patent Information Search



# Model program of Workshop & Invention Business Contest

## Day 1: Knowledge Sharing

Educate participants on patent information retrieval through lectures and questions

Lecture 1: “Basic Understanding of a Patent and Patent Search”

Lecture 2: “Introduction of Patent DB (WIPO DB, EU DB, US DB, Google DB)”

“How to use Espacenet and Patentscope for patent search”

Lecture 3: “Utilizing intelligence of patent information for revenue business models”

## Day 2: Invention Business Contest:

Tasks for patent information search are given and the search results are submitted within a set time.

Lecture 4: “Information and instruction of invention business contest”

Lecture 5: “Introduction of the technical subjects for patent searching”

Patent searching exercise

Reporting work

Presentation by participants

Evaluation of the contest results

Awarding & closing ceremony

# Achievement of Workshop & Invention Business Contest

## Achievements of Workshop & Invention Business Contest

2022										2023									
Mar	Apr	May	June	July	Aug	Sept	Oct	Nov	Dec	Jan	Feb	Mar	Apr	May	June	July	Aug	Sept	Oct
<b>3/14 DGIP, ID</b>																			
					<b>6/30 VIPRI, VN</b>														
						<b>9/1-2 Laos DIP, LA</b>													
							<b>9/8-9 IPOPHL, PH</b>												
								<b>12/5-6 IPVN, VN</b>											
										<b>2/15-16 Thai DIP, TH</b>									
													<b>3/1-2 MyIPO, MY</b>						
																	<b>3/14-15 MISTI, KH</b>		
																	<b>6/7-8 BruIPO, BN</b>		

Notes;

8 countries and 9 organizations have been completed of the workshop and invention business contest for the past 2 years.

Unfortunately, we could not hold the workshop and invention business contest in Myanmar and Singapore.

# Workshops and Invention Business Contests (DGIP, Indonesia)

Dates: March 14, 2022, Venue: DGIP Office as well as through Zoom platform

Number of participants: Workshop; about 50 participants, Contest; 13 participants

Awarded participants: 6 winners were awarded

Voice from IPO and participants:

Many participants commented that the contest helped them understand the importance of utilizing patent information, confirming the effect of dissemination and enlightenment.





# Workshops and Invention Business Contests (VIPRI, Vietnam)

Dates: June 30, 2022

Venue: VIPIRI, Ministry of Science and Technology

Number of participants: Workshop; about 50, Contest; 27 participants

Awarded participants: 2 people. Excellence Award, totally over 10 awarded

Voice from IPO and participants:

Participants requested that such events be held in the future. Increased the motivation of participants and confirmed the effect of dissemination and enlightenment





# Workshops and Invention Business Contests (DIP, Laos)

Dates: September 1-2, 2022, Venue: MOIC Meeting room, Laos

Number of participants: About 50 participants

Awarded participants: 1<sup>st</sup> winner; Second winners; 2, Third winners; 4

Voice from IPO and participants:

This Workshop and Contest is a very interesting event that help students, researchers and others. We would like to request to ERIA to support us to organize this kind of workshop/training to increase resident patent applications as a main priority.





# Workshops and Invention Business Contests (IPOP HL, Philippines)

Dates: September 6, 8 and 9, 2022, Venue: Adamson University, Manila

Number of participants: Workshop; 29, Contest; 21

Awarded participants: 1<sup>st</sup> winner; 1, 2<sup>nd</sup> winner; 1, 3<sup>rd</sup> winner; 2

Voice from IPO and participants:

The participants from various industry sectors actively participated during the training workshop and the contest. Also, they were able to properly utilize the various databases (IPOP HL Patent DB, USPTO AppFT/PatFT/Patent Public Search, WIPO Patentscope, EPO Espacenet) introduced by the lecturers.





# Workshops and Invention Business Contests (IPVN, Vietnam)

Dates: 5th- 6th December, 2022, Venue: Hanoi La Thanh Hotel

Number of participants: Workshop; Nearly 100 participants including online participants

Awarded participants: First winner; 1 from HCMC, Second winner; 1 from HCMC and 1 from Hanoi, Third winner; 3

Voice from IPO and participants:

A special feature is that besides the lectures, the seminar also organized a competition to search patent information on the basis of real situations. Practice combined with comments and assessments from the organizers will help participants gain more experience, thereby improving their search skills.





# Workshops and Invention Business Contests (DIP, Thailand)

Dates: February 15-16, 2023

Venue: Grand Richmond Hotel in Nonthaburi

Number of participants: 30 participants

Awarded participants: 3 Groups + encouraged groups

Voice from IPO and participants:

Most of participants were very much satisfied with this training course. Also, they suggested to hold DIP's future activities, such as Patent searching training, Patent valuation, How to draft patent, FTO and business strategy, IP management, etc.





# Workshops and Invention Business Contests (MyIPO, Malaysia)

Dates: March 1-2, 2023, Venue: MyIPO Building

Number of participants: 22 participants

Awarded participants: 5 Winners

Voice from IPO and participants:

The program was successful since the participants able to understand the method to do patent searching. The organizer was very proud with the enthusiasm showed by the participants during the workshop and contest. MyIPO hopes the cooperation with ERIA regarding patent information can be continued.





# Workshops and Invention Business Contests (MISTI, Cambodia)

Dates: March 14-15, 2023, Venue: ERA Phnom Penh Hotel

Number of participants: 35 participants

Awarded participants:

Voice from IPO and participants:

All the participants were really happy to receive an award and Certificate for winning the competition and learned from the experiences of this program. On behalf of the Ministry of MISTI, His Excellency hopes to continue the good cooperation with ERIA in the ongoing program related to the training of industrial property for the growth and development of intellectual property in Cambodia.





# Workshops and Invention Business Contests (BruIPO, Brunei Darussalam)

Dates: 7 - 8 June 2023

Venue: Golden Jubilee Hall, The Law Building, Attorney General's Chambers

Number of participants: 41 participants

Awarded participants: 3 Groups

Voice from IPO and participants:

Majority of the participants found the workshop to be very insightful as most of them had no prior experience in patent searching. The workshop had provided participants with hands-on practice which helped them to apply the different search techniques they learnt during the workshop. BruIPO will continue to future collaborations on workshops.





KEMENTERIAN HUKUM DAN HAKASASI MANUSIA REPUBLIK INDONESIA  
**DIREKTORAT JENDERAL KEKAYAAN INTELEKTUAL**  
JL HR Rasuna Said Kav 8-9 Kuningan, Jakarta Selatan 12940  
Telepon: (021) 57905617  
Laman: [www.dgip.go.id](http://www.dgip.go.id), Pos-el: [sesditjen@dgip.go.id](mailto:sesditjen@dgip.go.id)

---

## **REPORT**

### **WORKSHOPS AND INVENTION BUSINESS CONTESTS ON PATENT INFORMATION RETRIEVAL EDUCATION AND DISSEMINATION**

#### **A. OVERVIEW**

The Workshop and Invention Business Contest on Patent Information Retrieval Education and Dissemination was conducted on 14 March 2022 in a hybrid, at DGIP Office as well as through Zoom platform. The activity is jointly organized by the Directorate General of Intellectual Property (DGIP) and the Economic Research Institute for ASEAN and East Asia (ERIA). These activities are part of the ERIA series of activities in the ASEAN Region and also considered as a part of the series of activities under the celebration of the world Intellectual Property Day in Indonesia.

The activity was intended to provide opportunities for education, training, and dissemination and enlightenment regarding the methods of patent search and patent analysis for different stakeholder in Indonesia in order to foster the utilization of patent information, such as: future technology prediction, national policy making, competitiveness measurement between companies, corporate management strategy, R & D strategy, corporate value evaluation, explanation to shareholders and investors, setting research theme at universities and research institutes.

The activity consisted of two sessions, the first session was the workshop which was attended by 50 participants physically, and several participants/speakers by online. The attendees come from representatives of universities, research agencies, IP attorneys, and industries. There were several speakers from DGIP, BRIN (Indonesia National Research Agency), and several speakers from Japan which come from Patent attorneys, academic, and industrial.

The second session was the contest on patent searching which involved 13 contestants. They performed patent searches for the theme of cases of invention provided by a committee, after that they performed a presentation, and were assessed by a panel of jury that consisted of Senior Patent Examiner of DGIP and Experts from ERIA. There were 6 winners and the awarding ceremonies for the winners of the patent searching contest were held in the summit of the world IP Day celebration on 26 April 2022 at Graha Pengayoman Building, Ministry of Law and Human Rights.

## **B. RESULT**

The workshop and the contest provided several outputs which are

- Both the workshop participants and the contestants of the patent search contest gained knowledge about the importance of patent tracing in the stage of the invention process and how to conduct a proper and effective patent search so that it is also appropriate in determining the claim of an invention.
- The contest winners were as follows:
  1. Mr. Adi Setiya Dwi Grahito, BRIN (Indonesia National Research Agency)
  2. Ms. Karima Fadla, BRIN (Indonesia National Research Agency)
  3. Mr. Hanalde Andre, Andalas University
  4. Ms. Erry Yudha Mulyani, Esa Unggul University
  5. Ms. Nurul Azizah Ramadhani, Bogor Agricultural Institute
  6. Mr. I Made Bayu Dirgantara, Diponegoro University

## **C. FEED BACK FROM DGIP**

In overall, the workshop and the contest has been well organized. However, considering this kind of event is the first of a kind that have been conducted by DGIP, let alone the workshop is the first series of the workshop that is being held across ASEAN region, there is room for improvement for several matters.

With regards to the technical aspect of the workshop organization, It is strongly recommended that the workshop utilize interpreters in order to improve the

understanding of the participants. An interpreter and choice of language of instruction are a major element to the effectiveness of delivering the outcomes of the workshop.

The hybrid format of the workshop slightly reduced the communication and interaction between physical participants and the speakers. An appointment of a moderator could bridge the communication gap between the participants and the speakers in terms of substantial matters.

Furthermore, the shortened duration of the workshop (half day) also slightly hampers the effectiveness of the reception of the presentation of the speakers. There was no question-and-answer session which could enable participants to clarify several issues in order to fully grasp the material.

Moreover, at the same time due to several changes of regulations in Indonesia, particularly the beginning of physical lecture process in university, some of the university representative of the contest cancelled their participations since they have to teach offline/face to face class in their university

With regards to the speakers, the speakers are excellently appointed for both the qualification and the field of their knowledge. There were three different speakers from industries, lawyers, and the IP office which presented their knowledge matched with the needs of the participants that come from different backgrounds. The speakers also delivered their presentation excellently and possessed great knowledge in their field. Perhaps the main deficiency of the presentation is the lack of interaction between participants-speakers and also the language barrier.

With regards to the benefit of the workshop for DGIP, the activity, particularly the contest, provides a depiction of the level of utilization of patent information in Indonesia. This activity also provides a tool to assess the level of knowledge of the participants in the field of patent searching. Moreover, the result of this activity can be the basis for Indonesia to conduct related activities on patent, as well to formulate several policies in the field of utilization of patent information.



#### **D. Conclusion**

Workshop and Invention Business Contest on Patent Information Retrieval Education and Dissemination which jointly organized by DGIP and ERIA was successfully conducted. Even Though there were several deficiencies in the implementation, the evaluation of this workshop can serve as a basis of improvement of the organization of the next workshop organized by ERIA and the other ASEAN Member States.

DGIP wishes that activities like this can be carried out on an ongoing basis in order to educate and encourage stakeholders' understanding of the importance of the patent search process in determining claims for an invention so that it is targeted and effective which will then provide economic value.

# Hội thảo "Khai thác thông tin Sở hữu công nghiệp trên Nền tảng IPPlatform"

08:53 05/07/2022

Ngày 30/6, tại Hà Nội, Viện Khoa học sở hữu trí tuệ (VIPRI) phối hợp với Viện Nghiên cứu Kinh tế Đông Nam Á và Đông Á, Nhật Bản (ERIA) tổ chức Hội thảo "Khai thác thông tin sở hữu công nghiệp trên nền tảng IPPLATFORM". Hội thảo được diễn ra theo hình thức trực tiếp tại điểm cầu VIPRI kết hợp với trực tuyến tại điểm cầu ERIA Nhật Bản.

Tham dự Hội thảo, về phía Nhật Bản có sự tham dự của ông Toru Furuichi, Viện trưởng ERIA; ông Yoshitoshi Tanaka, Giáo sư danh dự, Viện Công nghệ Tokyo; luật sư Takashi Koyama, nguyên Giám đốc bộ phận quản lý SHTT, Bộ Ngoại giao Nhật Bản; ông Yori-hisa Katsunuma, Trưởng phòng SHTT, Công ty Ajinomoto Nhật Bản. Về phía Việt Nam có sự tham dự của ông Tạ Quang Minh, Viện trưởng VIPRI, đại diện các đơn vị trực thuộc Bộ Khoa học Công nghệ (KH&CN), các Sở KH&CN; đại diện các trường đại học, viện nghiên cứu, tổ chức trung gian, hiệp hội, cán bộ được giao vận hành các Trạm IPPlatform hiện có và dự kiến được thiết lập; các tổ chức đại diện sở hữu công nghiệp, doanh nghiệp và các cơ quan truyền thông, báo chí.



Toàn cảnh Hội thảo

Hội thảo được tổ chức gồm 02 phần: Phần 1. Hội thảo (Gồm 7 Chuyên đề liên quan đến tra cứu sáng chế và tra cứu nhãn hiệu do các chuyên gia đến từ Nhật Bản và chuyên gia của Viện KHSHTT trình bày); Phần 2. Thực hành khai thác thông tin SHCN (tổ chức cuộc thi tra cứu sáng chế và nhãn hiệu) nhằm mục tiêu: (i) phổ biến vai trò, tầm quan trọng của việc khai thác thông tin SHCN phục vụ hoạt động nghiên cứu, phát triển TSTT và quản trị TSTT của doanh nghiệp, tổ chức và cá nhân; (ii) nâng cao năng lực khai thác thông tin sáng chế và nhãn hiệu cho cán bộ làm công tác nghiên cứu, quản lý và cung cấp dịch vụ về SHCN...

Phát biểu khai mạc tại Hội thảo, ông Tạ Quang Minh, Viện trưởng VIPRI nhấn mạnh “thông tin SHCN đóng một vai trò đặc biệt quan trọng đối với hoạt động phát triển tài sản trí tuệ (TSTT). Bên cạnh việc duy trì và phát triển công cụ khai thác thông tin là Nền tảng IPPlatform, VIPRI phối hợp cùng với các sở KH&CN và các tổ chức thiết lập các Trạm IPPlatform để hướng dẫn khai thác thông tin và sử dụng dịch vụ SHCN một cách hiệu quả phục vụ hoạt động quản lý nhà nước về SHTT và hoạt động quản trị TSTT của doanh nghiệp, tổ chức và cá nhân. Việc tổ chức Hội thảo nhằm cụ thể hóa mục tiêu phổ biến, nâng cao kỹ năng khai thác thông tin SHCN cho các cán bộ làm công tác nghiên cứu, quản lý và cung cấp dịch vụ về SHCN. Thông qua việc tổ chức cuộc thi tra cứu sáng chế và nhãn hiệu giúp cho VIPRI đánh giá được mức độ, kỹ năng khai thác thông tin của người

dùng Nền tảng IPPlatform, từ đó có những định hướng cho giai đoạn tiếp theo của hoạt động tuyên truyền, phổ biến kỹ năng khai thác thông tin và sử dụng dịch vụ SHCN trên Nền tảng IPPlatform”.

Tại Hội thảo, các đại biểu đã được các chuyên gia Nhật Bản và Việt Nam chia sẻ về các vấn đề cơ bản về sáng chế, nhãn hiệu; tra cứu thông tin sáng chế, nhãn hiệu; khi nào và tại sao nên tiến hành tra cứu sáng chế, nhãn hiệu và hướng dẫn các bước tra cứu sáng chế, nhãn hiệu theo kinh nghiệm thực tiễn của Nhật Bản và Việt Nam.



Các đại biểu tham dự Hội thảo

Phần cuối của Hội thảo là cuộc thi tra cứu sáng chế và tra cứu nhãn hiệu với sự tham gia đông đảo, nhiệt tình của các đại biểu tham dự. Đơn vị tổ chức đã đánh giá và trao hai giải đặc biệt và các giải khuyến khích cho các đại biểu có kết quả thực hành tra cứu sáng chế và nhãn hiệu tốt nhất.



Hai đại biểu nhận giải đặc biệt cuộc thi tra cứu sáng chế và nhãn hiệu



Các đại biểu nhận giải khuyến khích cuộc thi tra cứu sáng chế và nhãn hiệu

Hội thảo đã diễn ra thành công tốt đẹp và nhận được sự đánh giá cao từ các chuyên gia, đối tác phía Nhật Bản và các đại biểu tham dự./.

*Viện Khoa học sở hữu trí tuệ*

- Tags:

## Tin cùng chuyên mục

---

- [Hội thảo "Hỗ trợ hoạt động quản trị tài sản trí tuệ thông qua công cụ khai thác thông tin sở hữu công nghiệp" \( 16:40 29/06/2022 \)](#)
- [Khai trương trạm IPPlatform và Hội nghị "Giới thiệu, hỗ trợ khai thác thông tin sở hữu trí tuệ trên Nền tảng IPPlatform" tại Bình Thuận \( 09:11 27/06/2022 \)](#)
- [Tập huấn, bồi dưỡng kiến thức về sở hữu trí tuệ và kỹ năng khai thác thông tin sở hữu công nghiệp tại Ninh Thuận \( 09:00 27/06/2022 \)](#)
- [Cuộc họp cấp cao giữa Trung tâm Quốc gia về đào tạo và thông tin sở hữu công nghiệp Nhật Bản - INPIT và Viện Khoa học sở hữu trí tuệ - VIPRI \( 11:43 24/06/2022 \)](#)
- [Kết quả hoạt động khai thác và vận hành Nền tảng Dữ liệu và dịch vụ sở hữu công nghiệp \(Nền tảng IPPlatform\) trong tháng 05/2022 \( 14:46 16/06/2022 \)](#)
- [Hội nghị tập huấn "Khai thác thông tin và cung cấp dịch vụ sở hữu công nghiệp" \( 09:23 27/05/2022 \)](#)
- [Kết quả hoạt động khai thác và vận hành Nền tảng Dữ liệu và dịch vụ sở hữu công nghiệp trong tháng 04/2022 \( 09:26 05/05/2022 \)](#)
- [Hội nghị "Nâng cao năng lực quản trị tài sản trí tuệ, khai thác thông tin và sử dụng dịch vụ sở hữu công nghiệp" tại Nam Định \( 12:16 04/05/2022 \)](#)
- [Khai trương Trạm IP Platform tại Hòa Bình, tổ chức lễ ký Thỏa thuận hợp tác về sở hữu trí tuệ và Hội nghị tập huấn "Nâng cao năng lực khai thác thông tin thông tin và sử dụng dịch vụ sở hữu công nghiệp" tại Hòa Bình \( 14:58 25/04/2022 \)](#)
- [Tháng Tư vấn, hỗ trợ miễn phí về sở hữu công nghiệp \(25/04/2022 - 24/05/2022\) \( 08:39 25/04/2022 \)](#)

## Tin mới cập nhật

---

- [Hội thảo "Hỗ trợ hoạt động quản trị tài sản trí tuệ thông qua công cụ khai thác thông tin sở hữu công nghiệp" \( 16:40 29/06/2022 \)](#)
- [Khai trương trạm IPPlatform và Hội nghị "Giới thiệu, hỗ trợ khai thác thông tin sở hữu trí tuệ trên Nền tảng IPPlatform" tại Bình Thuận \( 09:11 27/06/2022 \)](#)
- [Tập huấn, bồi dưỡng kiến thức về sở hữu trí tuệ và kỹ năng khai thác thông tin sở hữu công nghiệp tại Ninh Thuận \( 09:00 27/06/2022 \)](#)
- [Cuộc họp cấp cao giữa Trung tâm Quốc gia về đào tạo và thông tin sở hữu công nghiệp Nhật Bản - INPIT và Viện Khoa học sở hữu trí tuệ - VIPRI \( 11:43 24/06/2022 \)](#)
- [Kết quả hoạt động khai thác và vận hành Nền tảng Dữ liệu và dịch vụ sở hữu công nghiệp \(Nền tảng IPPlatform\) trong tháng 05/2022 \( 14:46 16/06/2022 \)](#)
- [Hội nghị tập huấn "Khai thác thông tin và cung cấp dịch vụ sở hữu công nghiệp" \( 09:23 27/05/2022 \)](#)

- Kết quả hoạt động khai thác và vận hành Nền tảng Dữ liệu và dịch vụ sở hữu công nghiệp trong tháng 04/2022 ( 09:26 05/05/2022 )
- Hội nghị "Nâng cao năng lực quản trị tài sản trí tuệ, khai thác thông tin và sử dụng dịch vụ sở hữu công nghiệp" tại Nam Định ( 12:16 04/05/2022 )
- Khai trương Trạm IP Platform tại Hòa Bình, tổ chức lễ ký Thỏa thuận hợp tác về sở hữu trí tuệ và Hội nghị tập huấn "Nâng cao năng lực khai thác thông tin thông tin và sử dụng dịch vụ sở hữu công nghiệp" tại Hòa Bình ( 14:58 25/04/2022 )
- Tháng Tư vấn, hỗ trợ miễn phí về sở hữu công nghiệp (25/04/2022 - 24/05/2022) ( 08:39 25/04/2022 )

## **NỀN TẢNG DỮ LIỆU - DỊCH VỤ SHCN**

# Report of Workshop and Contest

**Title:** Workshops and Invention Business Contests on Patent Information Retrieval Education and Dissemination

**Date:** September 1-2, 2022

**Location:** MOIC Meeting room, Laos

**Host:** DIP Laos with support by ERIA

## 1. Opening remark

Ms. Sida Youtrichanhthachack, Deputy Director General of DIP Laos  
Mr. Toru Furuichi, Director of ERIA.

## 2. Attendee(s)

50 participants from Universities, Research Institutes and DIP staffs in patent field.

## 3. Purpose

Provide the method of patent search, patent analysis to retrieve patent information from many databases and give a participants the opportunities to access to a new technology and innovation around the world.

## 4. Content of the Workshop

**(1) Importance of patent information for revenue business models** has learned to define IP strategy based upon business strategy; define the long-term vision of business; protect differentiating technology and revenue model by IP; utilize patent search information to strength business strategy;

**(2) Basic Understanding of a Patent and Patent Search** has learned what is patent system and patent right; patentable subject matter and exceptions; requirements for protection; publication of patent applications and patents; patent information search;

**(3) Basic patents vs. Improvement patents** has learned the expressions of basic patent and improvement patent; how patent information is published; tips to thinking about improvement inventions; what we should do to create an inventions; leadership for patent information searching education;



(4) **How to use databases** has learned how to access to databases; what kind of keyword should be use; which databases can be access;

(5) **When and for what purpose should we make patent information search** has learned what can find out through patent search; patent search on various stages in R&D through commercialization, and its purpose; contents of patent search.

## 5. **Out put**

The participants are interesting and understanding what they have learned, in the same time they can access to patent information by them self to use into their research and give them more idea to create new invention.

## 6. **Summary**

This Workshop and Contest is a very interesting event that help a students, researchers and others who interested in new technology and innovation but has no or do not know how to retrieve the information concerning their creation idea. Through this event, they can make a different to their society and also contribute to the national economics which is one of an important area to develop their country.

## 7. **Request**

Beside a strong points, there are also some weak points remain. Since a patent frame work in Lao PDR still quite limited to a public which lead to less of public awareness on patent, we would like to request to whom may concern especially ERIA to support us more on patent matters to organize this kind of workshop/training for at least to increasing a resident patent applications as a main priority.

Hope that we could have more cooperation in the near future!

Thank you very much.

Solasin Sengsilavong

Deputy Director

Patent Division

DIP Laos

**PATENT INFORMATION SEARCH SEMINAR & CONTEST**

Training on Patent Information Retrieval (Patent Search) and  
Patent Search Competition on Innovative Technical Solutions for Business

Intellectual Property Office of the Philippines (IPOP HL) and  
Economic Research Institute for ASEAN and East Asia (ERIA)

September 6, 8 and 9, 2022

Co Po Ty Hall

Dr. Carlos Tiu Center for Technology Innovation and Research Building  
Adamson University, Ermita, Manila

IP Business Services and Development Division (IPBSDD)  
Documentation, Information and Technology Transfer Bureau (DITTB) and  
Policy Research and International Affairs (PRIA) Division  
of IPOP HL

## **INTRODUCTION**

### **Background**

The Intellectual Property Office of the Philippines (IPOP) and the Economic Research Institute for the ASEAN and East Asia (ERIA) agreed to jointly pursue the promotion of utilization of patent information through the conduct of a training workshop on patent information retrieval, and an invention business contest. This project – which was generally intended to provide opportunities for education, training, and dissemination and enlightenment regarding the methods of patent search and patent analysis, among others - was based on the proposal of and conducted in coordination with the ERIA WG Leader Professor Yoshitoshi Tanaka.

IPOP also partnered with the Adamson University (AdU) – one of the successful Innovation and Technology Support Offices in the country - for the venue of the event. The event - which was funded by ERIA – was held at the Co Po Ty Hall, Dr. Carlos Tiu Center for Technology Innovation and Research Building of the University. It comprised the following sub-activities:

- Seminar-Workshop on Patent Information Retrieval (Patent Search) and
- Patent Search Competition on Innovative Technical Solutions for Business

### **Objectives**

With the importance of understanding patent information, its retrieval, and utilization, the project was aimed to (a) to increase awareness about patent information utilization, cultivate information retrieval and analysis skills, as well as promote further innovations, and (b) to provide opportunities for education, training, and dissemination regarding the methods of patent search, patent analysis, among others.

## **THE TRAINING WORKSHOP AND CONTEST**

### **Seminar-Workshop on Patent Information Retrieval (Patent Search)**

The Pre-event Webinar on Patent Information Search and Contest was conducted online on September 6, 2022, Tuesday, to brief the participants and at the same time introduce important topics relating to patent especially targeted for beginners. The following modules were discussed:

1. Introduction/Overview of the Patent Information Search and Contest – Engr. Wilfredo Calaguan, IPOPHL
2. Classification of Patent Documents – Ms. Ma. Winelma Garcia, IPOPHL
3. Introduction to Patent Search Tools and Databases – Engr. Francis Louise Gutierrez, IPOPHL
4. A Quick look at Patent Search Strategies and Search Report - Ms. Brianne Nicole Sanchez, IPOPHL

The Seminar-Workshop on Patent Information Retrieval (Patent Search) was held (face-to-face/on site) on September 8, 2022, Thursday, at the Co Po Ty Hall, Dr. Carlos Tiu Center for Technology Innovation and Research Building of AdU-Manila. The following activities/lectures were conducted:

1. Welcome Remarks – Atty. Teodoro Pascua, IPOPHL; Mr. Toru Furuichi, ERIA; and Dr. Venusmar Quevedo, AdU
2. Purpose of the Workshop - Atty. Louie Andrew C. Calvario, IPOPHL
3. Lecture 1: Basic Understanding of a Patent and Patent Search - Mr. Takashi Koyama, Oh-Ebashi LPC & Partners
4. Lecture 2: How to Use Patent Databases for Patent Search (IPOPHL Patent DB, USPTO AppFT/PatFT/Patent Public Search, WIPO Patentscope, EPO Espacenet) – Engr. Maricon Zabala, IPOPHL
5. Lecture 3: Utilizing Intelligence of Patent Information for Revenue Business Models - Prof. Fumihiko Moriya, Kanazawa Institute of Technology
6. Lecture 4: Why We Need Patent Information Searching? How is it Important? - Prof. Yoshitoshi Tanaka, ERIA/ Tokyo Institute of Technology
7. Lecture 5: Lecture and Demonstration on Patent Search/Information Retrieval - Engr. Wilfredo Calaguan, IPOPHL

The lectures were followed by Q& A discussions, in which the participants actively participated.

### **Patent Search Competition on Innovative Technical Solutions for Business**

The last leg of the event was the Patent Search Competition on Innovative Technical Solutions for Business which was held (face-to-face/on site) on September 9, 2022, Friday at AdU-Manila. The following activities were conducted:

1. Information and Instruction of Invention Business Contest - Prof. Yoshitoshi Tanaka, ERIA/ Tokyo Institute of Technology
2. Explanation of the Invention for Patent Searching - Prof. Yoshitoshi Tanaka
3. Patent Searching Contest Exercise (facilitated by IPOPHL/ERIA/AdU)

- a. Patent Searching
  - b. Submission of Search Report Form
  - c. Presentation of Search Results
  - d. Deliberation/ Announcement of Winners
4. Closing Remarks - Atty. Louie Andrew C. Calvario, IPOPHL

During the contest, the participants competed by conducting a patent search on either of the following:

- Own invention
- Already identified technologies which includes glass coating, razor cartridge, writing instrument, sheet as insulators for paper container, as provided for by ERIA.

The participants also presented their search results based on the format provided by Professor Tanaka, WG Leader of ERIA, which was agreed upon by both IPOPHL and ERIA.

After the tallying of scores and deliberation, the following were declared winners of the patent search competition:

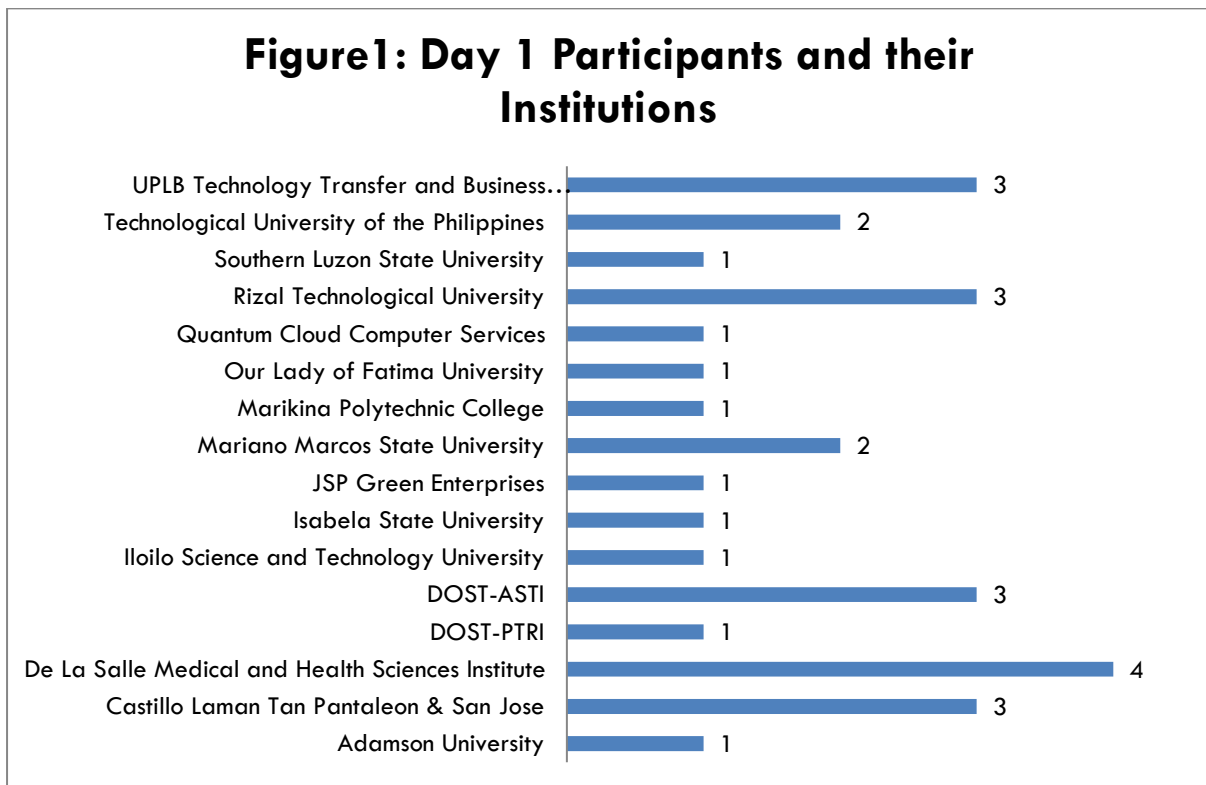
1. Alexandra Joyce Palacpac, JSP Green Enterprises (MSME/ Private Company) – First Place (25/30 points)
2. Lee Ann Diquiatco, Castillo Laman Tan Pantaleon & San Jose Law Offices (Law Firm) – Second Place (24.25/30 points)
3. Artbellosn Mamuri, Mariano Marcos State University (Academe) – Third Place (24/30 points)
4. Daryll Hanna E. Dulay, Our Lady of Fatima University (Academe) – Third Place (24/30 points)

The contest scores were based on the following criteria:

- Knowledge and understanding of patent information
- Knowledge and understanding of patent databases
- Keyword formulation
- Identification of patent classification
- Use of search strategies
- Relevance of search results (selected patent documents)

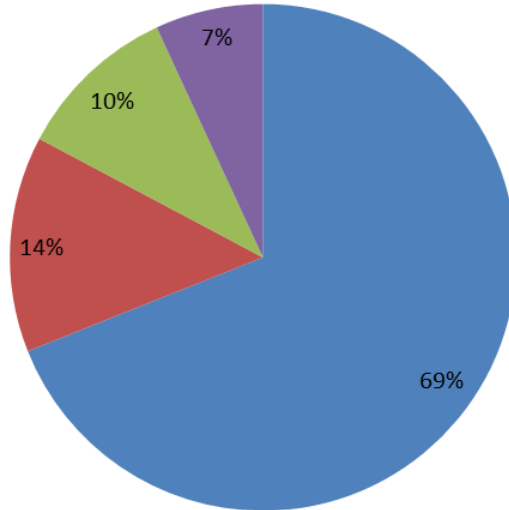
## Participants

The participants who attended the training workshop and joined the contest were mainly from the Academe (researchers, professors and students), Government, Law Firm and MSME/ Private Companies.

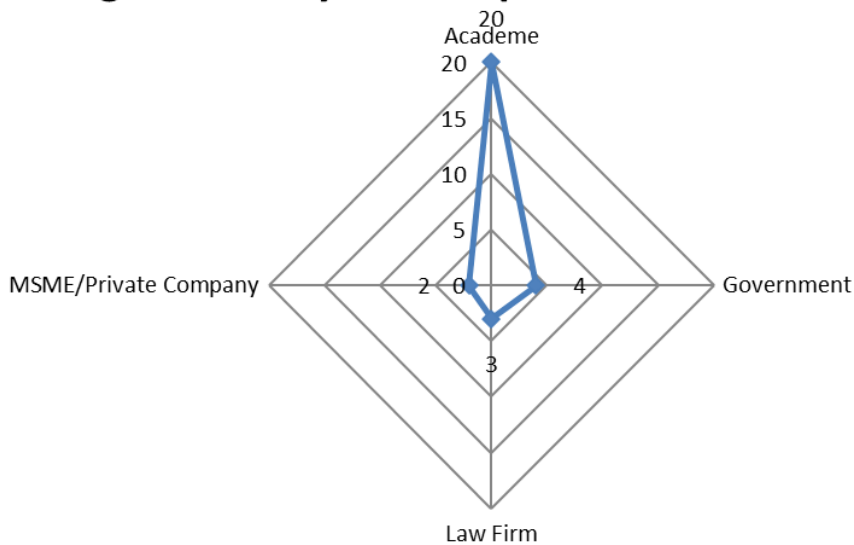


**Figure 2a: Day 1 Participants and their Sectors**

■ Academe ■ Government ■ Law Firm ■ MSME/Private Company

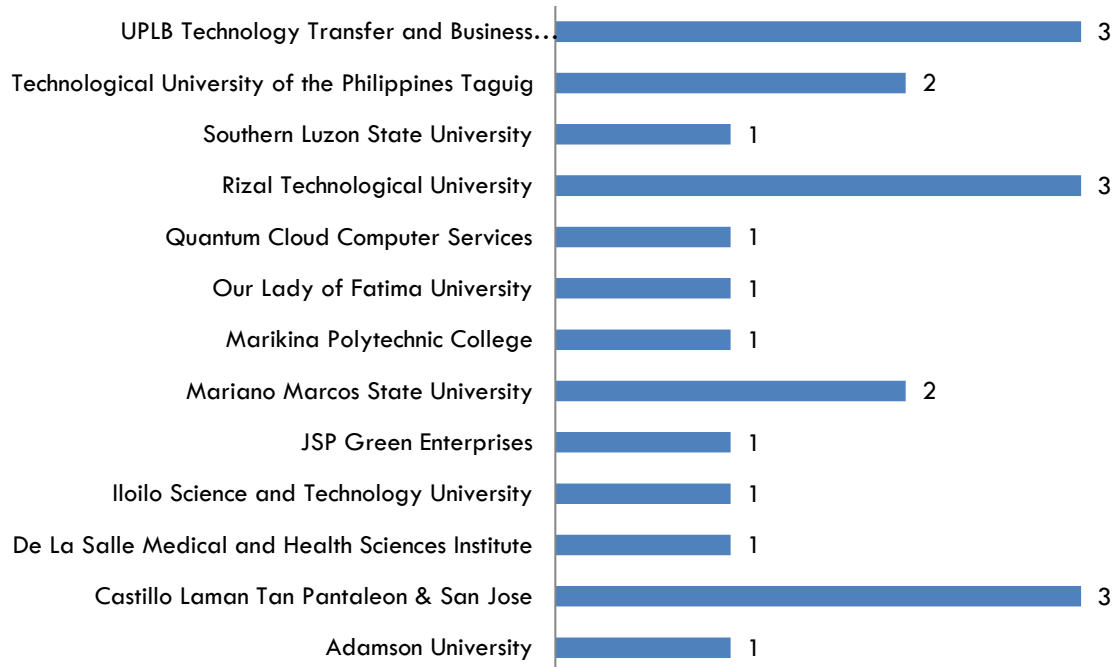


**Figure 2b: Day 1 Participants and their Sector**



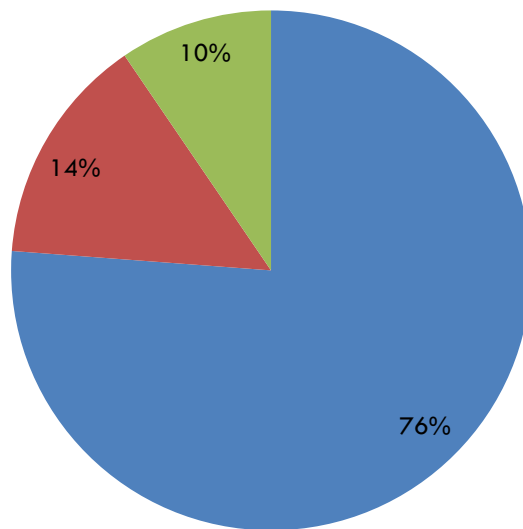
For the Training Workshop (Day 1), an overwhelming 69% comprising participants from the academe were mostly composed of professors, researchers and students. Almost equal in distribution were the participants from government, law firm and MSME/Private companies comprising 14%, 10% and 7% of the attendees, respectively (see Figures 1, 2a and 2b).

**Figure 3: Contest (Day 2) Participants and their Institutions**



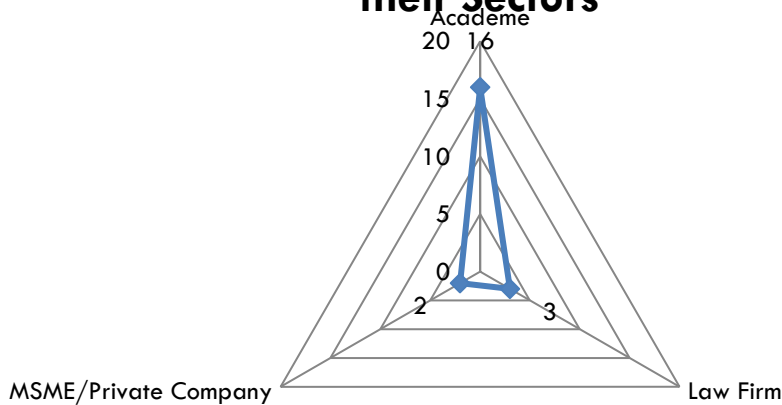
**Figure 4a: Constest (Day 2) Participants and their Sectors**

■ Academe ■ Law Firm ■ MSME/Private Company





**Figure 4b: Constest (Day 2) Participants and their Sectors**



During the patent search competition (Day 2), 76% of the participants were mostly from from the Academe, still comprising the greatest number of attendees based on industry sector. It was followed by the Law Firm and MSME/Private Companies with 14% and 10%, respectively.

## CONCLUSION

The participants from various industry sectors actively participated during the training workshop and the contest proper. Also, they were able to properly utilize the various databases (IPOP HL Patent DB, USPTO AppFT/PatFT/Patent Public Search, WIPO Patentscope, EPO Espacenet) introduced by the lecturers, conduct patent search and retrieve relevant patent information, and articulate their results well through the presentation of their search reports.

The contest results and scores - averaging 20.36 out of 30 points with the highest point of 25 - showed that the participants learned well from the training workshop and were able to apply their learnings through the actual conduct of patent search.

Prepared by:

Engr. Wilfredo O. Calaguan

OIC-Division Chief

IP Business Services and Development Division

Documentation, Information and Technology Transfer Bureau  
IPOP HL

## Report from IPVN regarding the project output

Sun, 01/01/2023 | 09:38 AM

Workshop and invention business contest on patent information search

With a unique combination of search training and contest, the workshop organized by the IP VIETNAM in collaboration with the Japan Patent Office (JPO) and the Economic Research Institute for ASEAN and East Asia (ERIA) aimed to promote the exploitation of patent information, contributing to innovation activities in Vietnam.

IP VIETNAM cooperated with JPO and ERIA to organize a workshop to train and practice searching for patent information. The conference was held in a live format combined with online streaming from 5th- 6th December, 2022 in Hanoi. This event attracted nearly 100 participants from institutes, universities, industrial property agencies and enterprises.

On the side of Japanese experts, there attended in person in Hanoi Mr. Toru Furuichi, Director General of Research Administration and Policy Design of ERIA; Mr. Fumihiko Moriya, visiting professor of Kanazawa Institute of Technology; Mr. Yoshitoshi Tanaka, professor emeritus of Tokyo Institute of Technology; and Mr. Nishimoto Koji, JICA's expert in Vietnam. The workshop also included online presentations by Mr. Takashi Koyama, Patent Attorney (Oh-Ebashi LPC & Partners), former Director of Intellectual Property Division of the Ministry of Foreign Affairs of Japan; and Mr. Yoriyisa Katsunuma, General Manager of Intellectual Property Department of Ajinomoto Co., Inc.

On the side of IP VIETNAM, there were Mr. Nguyen Van Bay, Deputy Director General and presenters from the Industrial Property Information Center, namely Ms. Nguyen Thi Thu Hien, Director; Mr. Bui Duy Nghia, Deputy Director; and Ms. Le Thi Quynh Hoa.



Mr. Nguyen Van Bay, Deputy Director General of the IP Vietnam, was giving the opening speech.

Mr. Toru Furuichi, Director General of ERIA was delivering the opening speech



Although it plays an important role in the research, development, production and business process, industrial property information in general, as well as patent information in particular, has been left an unexploited resource. This is a problem not only of Vietnam but also of many other countries in the world, as said by Mr. Nguyen Van Bay, Deputy Director General of the IP Vietnam at the workshop: “For a long time, the effectiveness of the patent protection system has often been assessed based on the exploitation of benefits related to patent right rather than based on the exploitation of patent information,”. “In Vietnam, the following reasons can be listed: Patent information has not yet become an urgent need of universities, research institutes and businesses; The communication on patent information has not been deep and wide, so the public's awareness is still limited; The language barrier makes it difficult to read and understand patent information...”.

In an effort to overcome these problems, IP Vietnam has coordinated with ERIA and JPO to organize this training workshop to disseminate skills in exploiting and using patent information. “The workshop will provide the necessary knowledge to search for patent information more quickly and conveniently,” said Mr. Toru Furuichi, General Director of ERIA.

“I believe that the shared knowledge from Japanese experts will be valuable lessons for IP VIETNAM as well as the Vietnamese public in promoting the exploitation of patent information, turning it into a really important resource in the process of research, development, production and business”, commented Mr. Nguyen Van Bay.



Organizers and delegates who attended directly in Hanoi

With the guidance of experts from Japan and the National Office of Intellectual Property, the participants in the workshop were guided in detail on how to search and exploit patent information through 7 topics: Overview about inventions and search for patent information; Introduction to Vietnamese and foreign patent databases (WIPO, EPO, USPTO, JPO...); Exploiting patent information for revenue models; Patent information search purposes; Strategies for searching patent information; Instructions on the steps of searching on domestic and foreign databases; Explanation of inventions to be searched.



A special feature is that besides the lectures, the seminar also organized a competition to search patent information on the basis of real situations. Practice combined with comments and assessments from the organizers will help participants gain more experience, thereby improving their search skills. On the second day, the delegates participated in a "competition" on searching for patent information. With a competitive atmosphere, the teams finished the exercise. The Organizing Committee has received 13 entries from the participants in both face-to-face and online formats.



The organizing committee evaluates the entries

After the evaluation process of the Organizing Committee, 6 entries were selected to receive gifts and commemorative papers from the event.

01 1st place entry:

- Nguyen Hoang Minh (online attendance from Ho Chi Minh City)

02 2nd place entries:

- Nguyen Thi Hong (online attendance from Ho Chi Minh City)

- Nguyen Van Hieu, Tran Thi Van Hanh (live attendance in Hanoi)

03 3rd place entries:

- Pham Tra My, Tran Binh Giang (direct attendance in Hanoi)

- Phan Thi Ai Hoa (online attendance from Ho Chi Minh City)

- Trinh Quoc Dat, Tran Thi Thuy Trang, Nguyen Duy Ha (online attendance from Ho Chi Minh City)





Mr. Toru Furuichi presents the medal to the second place team

Mr. Toru Furuichi presents the medal to the third place team



At the end of the workshop, the delegates expressed their thanks to the National Office of Intellectual Property and ERIA and JPO for giving them the opportunity to gain more knowledge and improve their patent search skills for other purposes. Delegates also wished that similar workshops will continue to be held in Vietnam.



Author: Thanh An – Thu Hien  
Translator: Nhat Quang

# Satisfaction Survey

28 responses

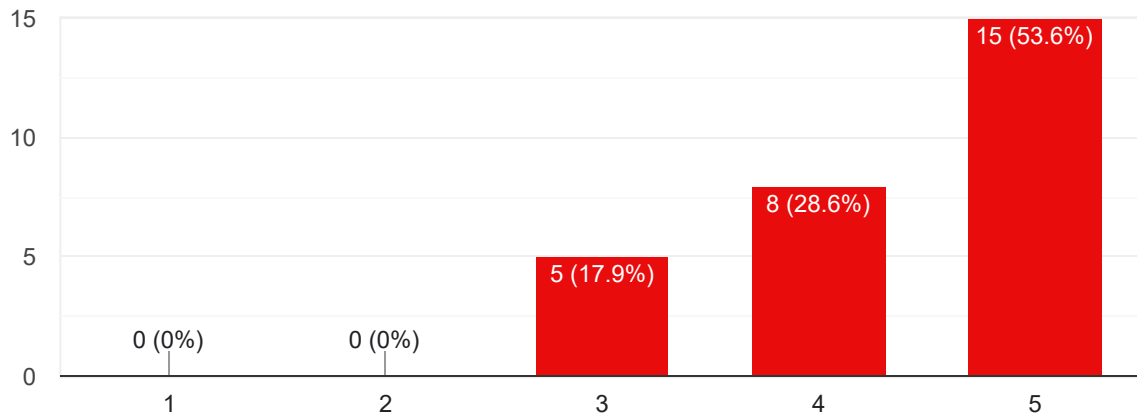
Logistics

How satisfied were you with the following?

## Timeliness of organisation \*

 Copy

28 responses

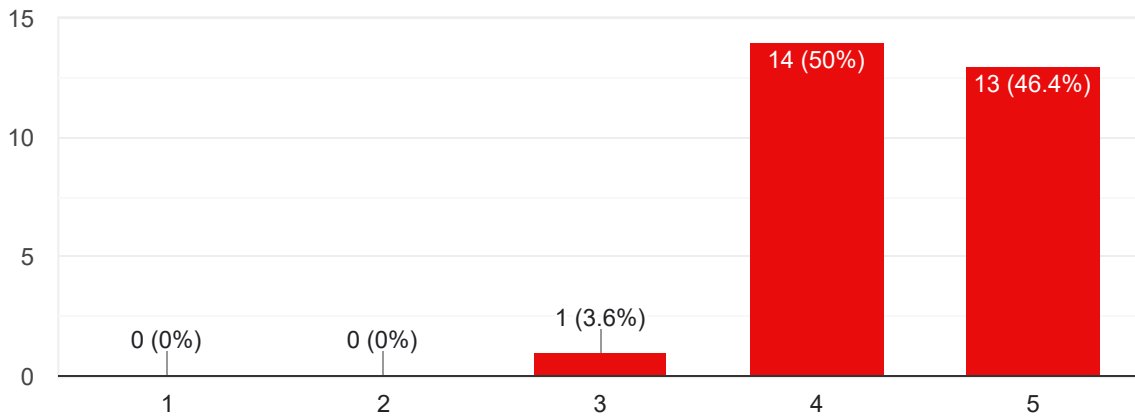




### Meeting room



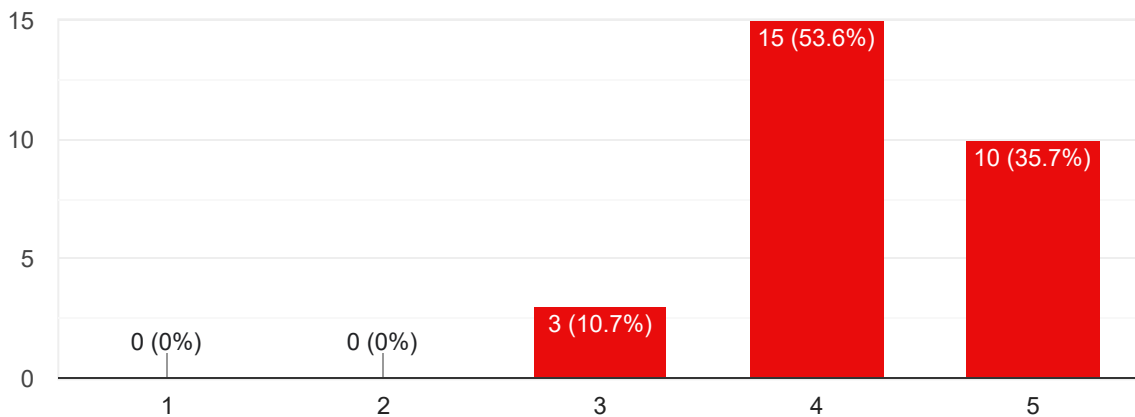
28 responses



### Overall event logistics organisation



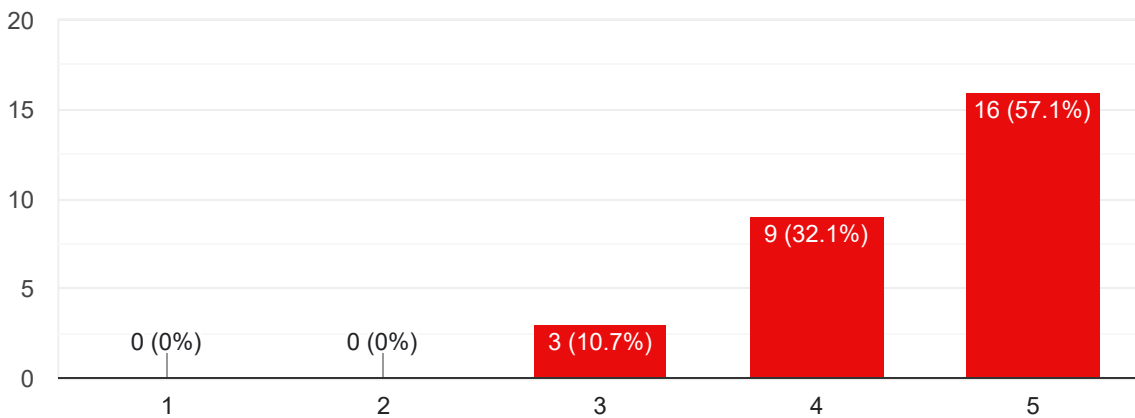
28 responses



### Staff helpfulness / Technical support



28 responses

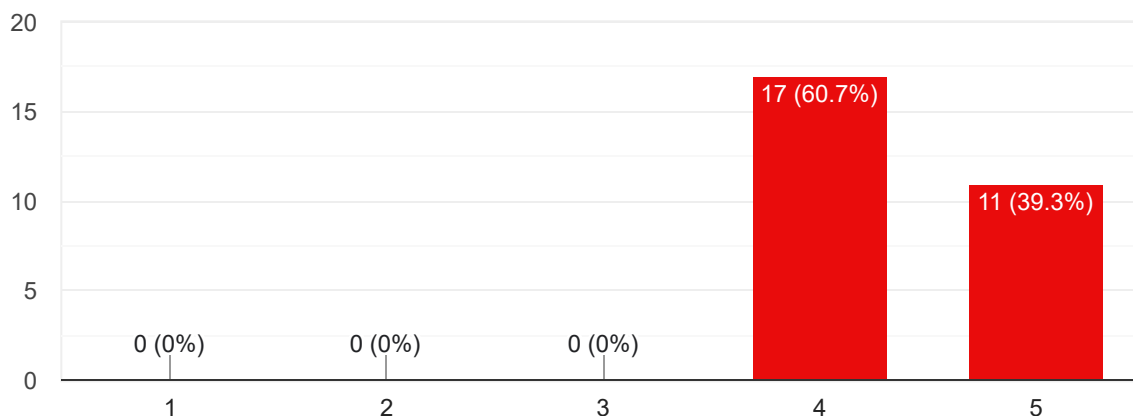


### Overall satisfaction

Are you satisfied with this event as a whole?



28 responses



Please specify why, particularly in case your answer is '3' or lower:

4 responses

Very satisfied

Uncontrollable factors.

More clarify problem and more time for presentation

The overall event is very good, but the session teaching about patent search database is quite too fast to follow.



## What are benefits or learning from this contest?

28 responses

Very comprehensive lectures and competition

Jdlenc

How to search for patent

The benefit is that we could apply the knowledge and techniques of patent search to practical use outside of the work field.

Fast search

learn technic to search patent

More understanding about how to use different search engines together to narrow down patent information.

Patent searching method and important of it

know more about other existing free databases

Learn how to use database for patent search

Good practice

How to use the search engine

Learn how to work proficiently and how to use patent data bases

normal focusing info for patent search

The detailed of DIP and WIPO search database.

International speakers

Patent searching technique

Understand about new patent database and how to search them

Improve skill of patent searching and know about other patent databases



step for search

We got more technique to search patent

Guide for patent utilization

Learn how to patent search.

Search technical in field phamaceutical, Find out FTO

Knowleges of IP Database

Leaning about IP basic knowledge and practics to use patent search database

I have leaned how to get the desired patent easily.

Learn how to use patent search database from variety sources



## Suggestion of topics/ areas for the future DIP's activities

13 responses

Patent search training

Pharmaceutical patent

Fully support DIP to continue and expand this activity.

Patent valuation

How to write patent for beginners

FTO for private sector

Patent valuation

It should be nice if have more time to practice

FTO and Business Strategy

1.Infringement Check 2.Create search report competition

IP valuation

IP management topic

Fundamental knowledge for people to get to know about IP

This content is neither created nor endorsed by Google. [Report Abuse](#) - [Terms of Service](#) - [Privacy Policy](#).

# Google Forms



## **Summary report of Program Patent Information Searching Workshop and Invention Business Contest by MyIPO**

### Outline of 2 days seminar

The program was attended by 22 participants although the earlier confirmed participation was 36 peoples.

On first day March 1<sup>st</sup> 2023, the program started at 9.15 am due to the connection problem. This is because MyIPO is in the process of moving to new building therefore the connection is unstable.

The welcome speech was delivered by ERIA Director General, Mr. Toru Furuichi, online basis through zoom. The opening speech was delivered by MyIPO Deputy Director General, Mr. Kamal Kormin on behalf of MyIPO Director General.

The workshop session started at 10.00 am at Computer Lab and the opening of the workshop was given by Mr. Shahrin from MyIPO regarding the purpose of the workshop. Then, Lecture 1 was given by Mr. Takashi Koyama, through zoom. However, due to connection unstable, Lecture 3 and 4 that initially planned to be delivered by Prof. Fumihiko Moriya and Mr. Yori-hisa Katsunuma were cancelled. The session was replaced by Prof. Yoshitoshi Tanaka.

On second day 2<sup>nd</sup> March 2023, the program started by explanation of the contest given by Prof. Yoshitoshi Tanaka. Then, after coffee break, patent searching contest started for about 2 hours and half. The participants reporting their work to 3 panels; Mr. Shahrin, Prof. Tanaka and Mr. Firdaus.

After careful evaluation, top five winners were selected. The list of the winners as follow:

First place: Dr. Azman Ismail

Second place: Nallyswari A/P Thiagarajan

Third place: Vincent Liew Chee Keong

Fourth place: Noorhisyam Yaacob

Fifth place: Zulhasni Abdul Rahim

### Conclusion

The program was successful since the participants able to understand the method to do patent searching. The organiser was very proud with the enthusiasm showed by the participants during the workshop and contest.

### Future Expectation

MyIPO hopes the cooperation with ERIA regarding patent information can be continued. Since MyIPO will be move to new building, we really hope this kind of event or any program from ERIA can be held in our new building. We are really happy to support any program proposed by ERIA for the sake of patent application improvement.

Kingdom of Cambodia

Nation Religion King



Ministry of Industry, Science, Technology & Innovation  
General Department of Industry  
Department of Industrial Property

Date : March 22,2023

## Summary Report

### The workshop and Contest on Patent Information Searching and its Utilization

- 1- The Workshop and Contest was held on March 14-15, 2023 at ERA Phnom Penh Hotel via Video online and physically.
- 2- The Workshop and Contest was Co-organized by The Ministry of Industry, Science, Technology & Innovation and the Economic Research Institute for Asean & East Asia (ERIA) presided over by **HE. Phork Sovanrith** , Secretary of State representative of H.E. **Kitti Setha Pandita CHAM Prasidh**, Senior Minister, Minister of Industry, Science Technology & Innovation and **Mr. Toru Furuichi**, Director General for Research and Policy Design Administration, ERIA and attended by relevant institutions such as : The Institute of Technology of Cambodia, General department of Science Technology & Innovation, the Royal University of Phnom Penh, The Royal University of Agriculture Chamkar Dong, Kosomak Polytechnic Institute, and National Polytechnic Institute of Cambodia, Cambodian Intellectual Property Association, IP Agent and Law firm in total 35 persons.
- 3- This workshop is to enhance the consciousness of securing and protecting the research achievements for researchers, start-ups and university students in the field of science and engineering including digital technologies and to share patent information and searching methods and basic knowledge of patent information utilization to local universities, IP agents and researchers, etc.
- 4- In the opening remarks by H.E. Phork Sovanrith, Secretary of State of MISTI, the Chair expressed his sincere thanks to **Mr. Toru Furuichi**, Director General for Research and Policy Design Administration ERIA (**Presenting Online**), **Mr. Yoshitoshi Tanaka**, Professor Emeritus, Tokyo Institute of Technology for choosing Cambodia as the host country for this important workshop and welcome all participants, the project team, and the members of ERIA who are present video online. He also mentioned that this is the first project that the Economic Research Institute for ASEAN (ERIA) and MISTI jointly organized and implemented. **Patent Information** is the source of technical, commercial and legal information of a patent. It shows **bibliographic data** and **patent specification**. Patent documents contain important legal information of the patent including the information of the owner of the patents, the location where the patent is filed, the filing date, the publication date as well as **the title of the invention, the abstract, description, patent claims** and the **drawings** where applicable. Understanding this information is of significant importance to researchers, inventors, lawyers and relevant stakeholders.
- 5- The main presentations discussed were:
  - a. Basic Understanding of a Patent and Patent Search”
  - b. The procedure of Patent filling and grant in Cambodia, Espacenet EPO -DB for patent search”
  - c. Utilizing intelligence of patent information for revenue business models”
  - d. When and for what purpose should we make patent information search”
  - e. Lecture and demonstration on patent information searching.
  - f. Information and instruction of invention business contest

- g. Explanation of the invention for patent searching by ERIA WG ( 3 cases )
  - h. And Patent searching contest exercise
- 6- During the two-day workshop, the participants had a lively discussion and raised questions to our speakers, and the speakers explained in detail to the workshop, which resulted are:
- a. Basic knowledge in searching patent information and using this information for development in their business.
  - b. How to research inventions and determine the scope of pre-existing technology for technological researchers who want to find information related to their technology designed to develop their creative ideas.
  - c. Gain knowledge and experience from contest exercises, practice directly and have team competition, with the explanation of each presentation to defense of their assignment. And finally, three teams of winning exercise researchers were awarded as the results of the two-day workshop.
- 7- At the end of the workshop, there was an evaluation by **Professor Yoshitoshi Tanaka**, Professor Emeritus, Tokyo Institute of Technology, explaining how to solve problems and limit the scope of technical search, which is a good result obtained from all participants. Conducted Contest Exercise to gain knowledge and experiences about patents information from developed countries, which already have tens of thousands of patents.
- 8- On behalf of ERIA, the professor Tanaka-san thanked all the participants for participating in the workshops and competitions in their efforts to study, research and practice the exercises to get good results. He would like to thank the Ministry of Industry, Science, Technology and Innovation for co-organizing this contest workshop. In searching patent information, there is a lot of data that we want to apply for any business. He hopes to meet again in the future and continue to cooperate and work well together.
- 9- At the closing remarks, On behalf of the Ministry of Industry, Science, Technology and Innovation, HE Ven Keahak, Undersecretary of State, appreciated the Working Team of the Department of Industrial Property for coordinating to organize this event, and the participants actively participated. He **Deeply thanks to Mr. Toru Furuichi**, Director General for Research and Policy Design Administration, ERIA and all the speakers who made the online presentation, explained and comprehensively presented in detail. Special **thanks to Professor Yoshitoshi Tanaka** Professor Emeritus, Tokyo Institute of Technology for his efforts in facilitating this program. All the participants were really happy to receive an award and Certificate for winning the competition and learned from the experiences of this program. His Excellency hopes that the experiences gained from the experts will help to expand the knowledge of all participants in their work related to the Patent search of this vast amount of patent information.
- 10- His Excellency believes that under the high support and guidance of His Excellency, the Honorary Senior Minister, Minister of MISTI the research, development and innovation as well as the protection of industrial property will continue to be widely disseminated in Cambodia for the future.
- 11- On behalf of the Ministry of MISTI, His Excellency hopes to continue the good cooperation with ERIA in the ongoing program related to the training of industrial property rights with other topics for the growth and development of intellectual property in Cambodia.

Reported by : **Ms. Or Vandyma**  
Deputy Director  
Department of Industrial Property  
Tel: 855-12 453 285



# **SUMMARY REPORT ON BRUIPO-ERIA EVENT**

**TITLE:** BrulPO-ERIA Joint Event

**DATE:** 7 - 8 June 2023

**TIME:** 9.00AM - 4.30PM

**VENUE:** Golden Jubilee Hall, The Law Building, Attorney General's Chambers

**ORGANISER:** Economic Research Institute for ASEAN and East Asia (ERIA) and Brunei Intellectual Property Office Brunei Darussalam (BrulPO)

## **INTRODUCTION**

1. As part of ERIA's ongoing research project on the *current situation and the future task of local companies and universities on patent information utilisation for promotion of innovation in ASEAN countries*, this 2-day event was jointly organised by ERIA and BrulPO. Similar events had also been held in other ASEAN Member States as well.
2. The workshop, inaugurated by Yang Berhormat Dato Seri Paduka Awang Haji Ahmad bin Pehin Orang Kaya Laila Setia Bakti Di-Raja Dato Laila Utama Haji Awang Isa, the Honourable Attorney General, who is also the Registrar of Trade Marks, Patents and Industrial Designs, expressed gratitude to ERIA for the invaluable support in organising this event, notably for their expert guidance in enriching the participants' understanding of patent information search and its implications for business growth.
3. Those attended were professors, researchers, Ph.D / Masters students and entrepreneurs.

## **OBJECTIVE**

4. The workshop is intended to promote the importance of patent information utilization in Brunei Darussalam. This could be achieved by educating and training individuals regarding methods of patent search and patent analysis from Mr. Takashi Koyama, Professor Fumihiko Moriya, Mr. Yorihsa Katsunumma and Professor Yoshitoshi Tanaka, who shared the best practices for patent information search and explaining how this can catalyse economic growth and technological advancement.

## **POINTS OF DISCUSSION**

### **Day 1 (Workshop on Patent Information Search and Utilisation)**

5. The first day of the event consisted of a Workshop with a focus on Patent Information Utilisation, where participants gained a comprehensive understanding of patents, and how to conduct patent information search effectively, through presentations given by the experts mentioned above.

## **Day 2 (Invention Business Contest)**

6. The second day consisted of a contest led by ERIA and facilitated by BruIPO. Participants took part in hands-on activities designed to deepen their knowledge and proficiency in patent information searching. To showcase their newfound knowledge, the participants were required to present their case study-based patent search exercise in groups of 5-6 (groups were formed based on their educational institution). An award ceremony was held to conclude the event, in which the top 3 winners of the contest were awarded with cash prizes. Significantly, 1st place fell to the Universiti of Brunei Darussalam, which comprised both Ph.D / Masters students, winning \$350 cash.

## **PARTICIPANT'S GENERAL FEEDBACK**

7. Majority of the participants found the workshop to be very insightful as most of them lacked/had no prior experience in patent searching. The workshop had provided participants with hands-on practice which helped them to apply the different search techniques they learnt during the workshop. Participants also expressed their eagerness to attend similar workshops in the near future.

## **EVALUATION/OBSERVATION**

8. The event went smoothly and successfully, allowing participants to actively engage with the speakers and take part in the competition with enthusiasm. The practical segment of the event was also conducted with ease, though, due to the time constraint during the competition, certain participants, particularly the students, required more time to conduct their patent information search due to the lack of prior knowledge and experience in this area.

## **WAY FORWARD**

9. In light of the positive feedback from the participants and the office, BruIPO will continue to seek guidance from ERIA regarding patents and other relevant areas and looks forward to future collaborations with ERIA on similar workshops.